



Wide Dynamic Range Camera

WAT-233

Operation Manual

This Operation Manual covers safety, camera functions, installation and the correct operating procedure for the WAT-233. First, we ask you to read this Operation Manual thoroughly, then install and operate the WAT-233 as advised. In addition, for future reference, we also advise safekeeping of this manual.

Please contact the distributor or dealer from which the WAT-233 was purchased, if you do not understand the installation, operation or safety instructions laid out in this manual. Not understanding the contents of the Operation Manual sufficiently may cause damage to the camera.

Guide to the Safety Symbols

The definitions of the symbols used in this operation manual are:

When you do not adhere to or take notice of the "Danger" sign, it may lead to a serious accident such as death or injury caused by fire or electric shock.

When you do not adhere to or take notice of the "Warning" sign, it may cause severe damage such as a physical injury.

When you do not adhere to or take notice of the "Caution" sign, it may incur injury and cause damage to peripheral objects in the immediate surroundings.

Cautions for Safety

The WAT-233 is designed to be used safely; however, if not used safely, it may lead to a physical accident caused by fire and electric shock. Therefore, please keep and read the "Cautions for safety" below for protection against accidents.

Do not disassemble and/or modify the WAT-233.
Do not operate the WAT-233 with wet hands.

Use a stabilized power adaptor designed for DC+12V±10%, with a current capacity of more than 250mA for the WAT-233. The recommended voltage is DC+12V±10%
Do not expose the WAT-233 to wetness or high moisture conditions.

The WAT-233 is designed and approved for indoor use only. The WAT-233 is not water-resistant or waterproof. If the location of the camera is outdoors or in an outdoor like environment, we recommend that you use an outdoor camera housing.
Protect the WAT-233 from condensation. Keep the WAT-233 dry at all times during storage and operation.
Should the camera not work properly, switch off the power immediately. Then check the camera according to the "Problems and Trouble shooting" section.

Avoid the striking of hard objects or dropping the WAT-233. The WAT-233 uses high quality electrical parts and precision components.
Do not connect any power supply directly to the video out terminal of the unit. Do not connect the WAT-233 with any monitor using a video/power single transmission terminal. The WAT-233 is not designed for use with this type of equipment. We also advise you to read the operation manual of the monitor you plan to use before any connections are made.
Do not install the WAT-233 in a position subject to direct sunlight. Sunlight shinning directly onto the WAT-233 lens can cause damage to the CCD.
Select a stable place for installation of the WAT-233. Use a support of durable strength around an installation position on a ceiling or wall when a camera stand or tripod is used.
Do not move the WAT-233 with the cables connected. Before moving the WAT-233, always remove the video cable and power cable from the rear of the camera first.
Avoid using the WAT-233 near any strong electro-magnetic field. After installing into main equipment, if the WAT-233 is exposed to electromagnetic waves causing the monitored image to become distorted, we recommend the camera be shielded by appropriate protective casing.

Problems and Trouble Shooting

If any of the following problems occur when using the WAT-233,

- An optimal picture cannot be obtained, after checking that all the cables and connections are correctly in place
- Smoke or any unusual odor emerges from the WAT-233
- An object becomes embedded or a quantity of liquid seeps into the camera housing
- More than the recommended voltage or/and amperage has been applied to the WAT-233 by mistake
- Anything unusual occurring to any equipment connected to the WAT-233

Disconnect the camera immediately according to the following procedures:

- Switch off the main power supply to the camera.
- Remove the power and video cables connected to the WAT-233.
- Contact the distributor or dealer from which the WAT-233 was purchased.

About EMC

The WAT-233 is in conformity with EMC test standards carried out by authorized organizations in Japan.

NTSC FCC Part15 class B
P A L EN61000-6-3/EN50130-4

※Please use an auxiliary power supply (eg: UPS) to this camera to comply with EN50130-4 of EMC standards.

Do not modify the WAT-233. A modified camera may not conform to EMC test standards.

Contents

Using the contents figures below, check to make sure all parts are present before use.

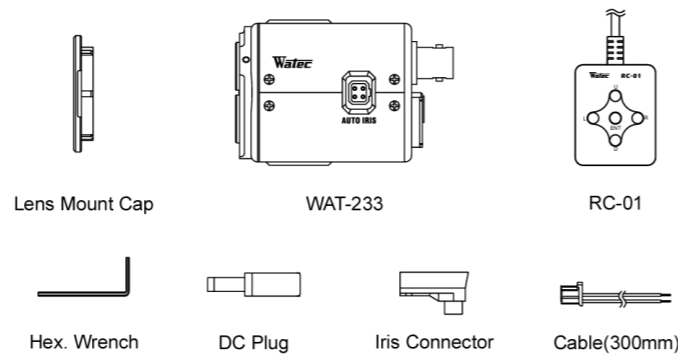

Description of Parts

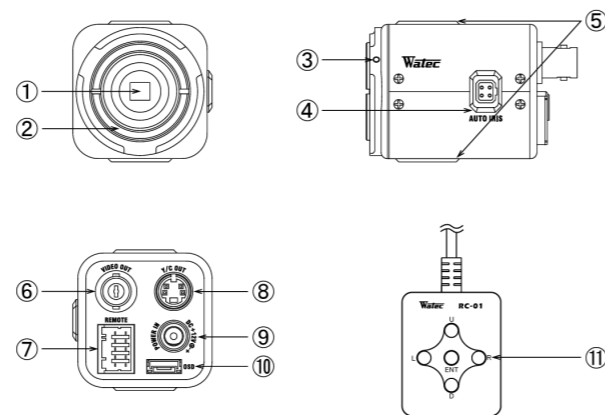

- IMAGE SENSOR FRONT FACE**
 - The light receiving face of the image sensor (Dirt, water or oil deposits on the image sensor will cause an unclear picture on the monitor. Attach the lens cap to protect the lens and the CCD from contamination and damage.)
- LENS MOUNT**
 - Mount for the lens (CS-mount)

- FINE FOCUS ADJUSTMENT SCREWS**
 - There are 3 hex. adjustment screws each placed at intervals of 120° for fine focusing of the lens.
- AUTO-IRIS SOCKET**
 - This socket is for the video/DC auto-iris lens cable connector. (Video/DC: Auto selected by the camera)
- TRIPOD MOUNTING SCREW HOLES**
 - Mounting holes for stands. The size of these threads are 1/4", 20 threads, 4.5 ±0.2mm, which is the same as any standard camera tripod (U1/4").
- VIDEO OUT (BNC)**
 - The terminal for composite video signal output
- I/O CONNECTOR**
 - The control terminal for the RS-232, ALARM and infrared cut filter changer.
- Y/C OUT**
 - The terminal for Y/C signal output.
- POWER IN**
 - The terminal designed for connection with the DC-plug of the power adaptor.
- OSD(On Screen Display) CONNECTOR**
 - The terminal designed for connection with the remote control for setting the functions on the screen.
- OPERATION BUTTON**
 - The operation button for setting the functions on the screen.

Power Supply

Use a stabilized power adaptor designed for DC+12V±10%, with a current capacity of more than 250mA. Use the optional DC plug if the shape or polarity of the DC plug of the power adaptor to be used is not compatible with the camera (See the drawing on the right below).



The wiring of the connector must be exact. Be careful not to touch the other terminal while wiring. Protect the wiring portion by using insulation tape after wiring. If the above care and attention is not adhered to, damage to the WAT-233 and power adaptor may occur and may also cause fire.

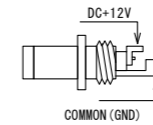

Auto-iris Lens

Before connecting the auto-iris lens, please make sure that the pin configuration is correct by confirming with the following table. If the configuration of your iris connector is different from the following, the plug and pins will need to be rewired.

Pin No.	EIAJ Video Auto-iris Lens Arrangement	EIAJ DC Auto-iris Lens Arrangement
①	Power	Control -
②	Not used	Control +
③	Iris signals	Drive +
④	Common (GND)	Drive -

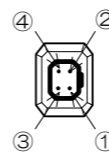

Mechanical Back

Mechanical Back(M.B) is the projection from the lens mount to the camera. Use a lens with a mechanical back that is less than 5.0mm to the WAT-233.

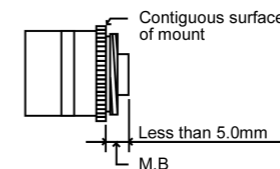

Set-up and Operation

- Ensure that the power to the WAT-233 and the peripheral equipment is turned off before making any connections.
- Remove the lens mount cap from the WAT-233 and attach the CS-mount lens. Use the optional C-mount adaptor (34CMA-R) when a C-mount lens is used.
- Connect the iris control cable to ④AUTO-IRIS SOCKET on the WAT-233 when an auto-iris lens is being used.

- Connect ⑥VIDEO OUT on the WAT-233 with the monitor, using a coaxial cable with 75Ω impedance, such as an RG-59 or an RG-6/U. If the monitor has an S-terminal, high resolution imaging is possible by connecting with ⑧Y/C OUT.
※The ⑧Y/C OUT can be used together with the ⑥VIDEO OUT.
※Select a monitor with the same television system as the WAT-233 NTSC or PAL. A monitor with more than 700TV lines is recommended.
- Insert the power plug of the power adaptor into ⑨POWER IN on the back panel of the WAT-233. Confirm that the power adaptor is not connected to the power supply before insertion of the power plug into ⑨POWER IN.
- Turn on the power to the WAT-233, monitor and all other allied equipment. When a picture cannot be obtained on the monitor, or a problem occurs, check and follow the procedure mentioned in the [Problems and Trouble Shooting] section.
- After following the procedure below and the picture is still out of focus, open the iris fully and loosen ③FINE FOCUS ADJUSTMENT SCREWS with the hex. wrench and move the lens forwards until a clear picture is obtained.

Manual Lens	Adjust the focus and iris to the best position on the lens.
Video Auto-iris Lens	Adjust the focus on the lens/camera, then adjust the focus on the lens. .
DC Auto-iris Lens	Adjust the iris level on the camera, then adjust the focus on the lens.

※When using a DC Auto-Iris lens, adjustments to the iris level can be done by changing the level in the OSD menu by use of the remote control (RC-01) included. Please refer to the User's Manual.

- When detailed settings are required or an adequate image is not obtained, connect the remote control(RC-01) to ⑩OSD(On Screen Display) CONNECTOR, then set the functions on the screen by ⑪OPERATION BUTTON.
- When controlling the RS-485, alarm output and infrared cut-filter changer, connect to ⑦I/O CONNECTOR after wiring using the attached cable. See the pin configuration as follows.

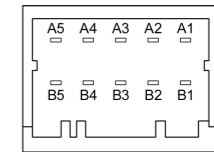

(Camera side)

PIN No.	Cable color	Title	Function	
A1	Green	D/N EXT CTL(+)	DAY/NIGHT external control (Photo coupler input, Polar)	
B1	Green/White	D/N EXT CTL(-)		
A2	Purple	D/N STATE OUT(1)	DAY/NIGHT state output (Photo MOS relay output, Nonpolar)	
B2	Purple/White	D/N STATE OUT(2)		
A3	Orange	ALARM (1)	Motion detection alarm out (Photo MOS relay output, Nonpolar)	
B3	Orange/White	ALARM (2)		
A4	-	NC	-	
B4	Black	GND	RS-485 (non-isolated)	Camera GND
A5	Gray	RXD (+)		Data input from the camera side
B5	Gray/White	RXD (-)		Data input from the camera side

External DAY/NIGHT control terminal

When EXT mode DAY/NIGHT image setting is selected, the camera mode can be changed from DAY to NIGHT (IR-cut filter removed) by an applied voltage of 3 to 12V between the terminals A1 and B1 (current value: 1mA at 3V and 6mA at 12V). By connecting a light sensor as indicated in the diagram below, DAY/NIGHT modes can be controlled according to the lighting condition of the monitored object. Please make sure the electrical polarity is correct when connecting the cables.

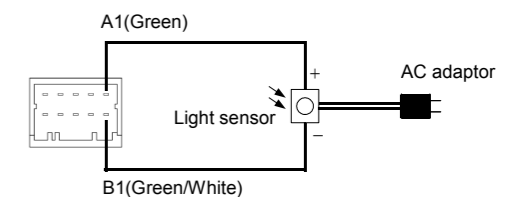

DAY/NIGHT status output terminal

When in NIGHT mode (IR-cut filter removed), the terminals A2 and B2 are closed circuit, therefore, the IR projector system is turned on if it is attached as the diagram indicated below. Please make sure that the attached IR projector system supply voltage is 16V or less and the output current is 250mA or less.

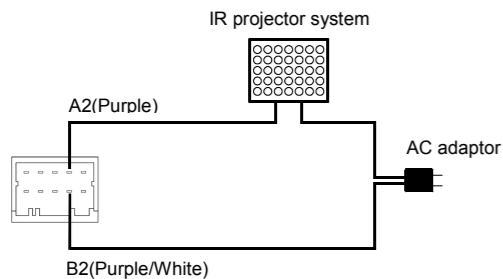

Alarm output terminal

When the motion detection function is selected, the alarm output terminals, A3 and B3, are closed circuit by detecting any movement in the monitored area. If an alarm is attached as the diagram indicated below, the alerting system (sound, light, etc.) turns on by the closed circuit. Please make sure that the attached alarm supply voltage is 16V or less between the 2 terminals and the output current 250mA or less.

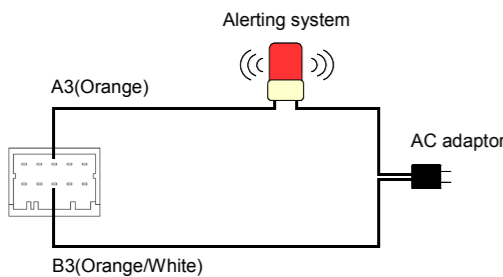

※When connecting to the induced load(relay, motor) or incandescent electric lamp, take measures against surge voltage and inrushing current on the outside circuit.

RS485 Communication

OSD operation is possible through the use of the RS485 communication line and a PC or Pelco-D protocol compatible DVR, Controller, etc... (refer to diagram below).

The voltage levels between the input terminals A5(RXD[+]) and B5(RXD[-]) must be between -7 to +12V. Please take caution to connect the input terminals with the correct polarity. Please refer to the user's manual for the RS485 compatible equipment for proper connection and use.

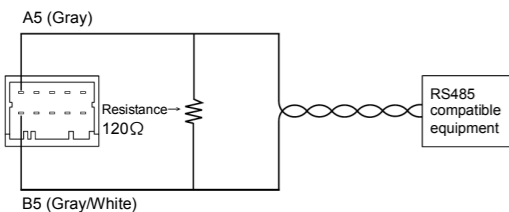

※The Camera does not have a termination resistor, therefore, as needed, please terminate the connection on the cable side (Termination Resistor 120Ohms)

Specifications

Model	WAT-233 (NTSC)	WAT-233 (PAL)	
Pick-up Element	1/3 inch 960H interline transfer CCD image sensor		
Number of Total Pixels	1028(H)×508(V)	1028(H)×596(V)	
Number of Effective Pixels	976(H)×494(V)	976(H)×582(V)	
Unit Cell Size	5.0 μm(H)×7.4 μm(V)	5.0 μm(H)×6.25 μm(V)	
Sync. System	Internal		
Scanning System	2:1 Interface		
Video Output	Composite	Composite Video, 1.0 V(p-p), 75Ω (Unbalanced)	
	Y/C	Y: 1.0 V(p-p), C: 0.3 V(p-p) 75Ω	
Resolution	More than 650TVL (Center)		
Minimum Illumination	Color	0.01 lx F1.2 (AGC=ON, Shutter=OFF, NR=ON, γ=0.45)	
		0.0006 lx F1.2 (AGC=ON, Shutter=x16, NR=ON, γ=0.45)	
	Monochrome	0.0005 lx. F1.2 (AGC=ON, Shutter=OFF, NR=ON, γ=0.45)	
		0.00003 lx. F1.2 (AGC=ON, Shutter=x16, NR=ON, γ=0.45)	
S/N	More than 50dB (AGC=2dB, γ=1.0)		
AE Mode	Fixed	x2, x4, x8, x16, x32, x64, x128, x256 (field)	
		1/60, 1/100 sec.	1/50, 1/120 sec.
		1/250, 1/500, 1/1000, 1/2000, 1/4000, 1/10000 sec.	
	EI	1/60 - 1/100000 sec.	1/50 - 1/100000 sec.
	x16 - 1/100000 sec.		
AGC	HI: 2~44dB / LO: 2~32dB		
MGC	2~44dB (1dB step)		
Gamma Characteristics	9 steps setting (1.0/0.8/0.7/0.6/0.55/0.5/0.45/0.4/0.35)		
White Balance	ATW, PWB, MWB, PRESET (4 types)		
Day/Night	Auto (Level selectable) / Manual / External		
Wide dynamic range	ON (Level selectable) / OFF		
Noise reduction	3DNR ON (Level selectable) / OFF		
Lens-iris	Video / DC		
Back Light Compensation	ON / OFF		
HSBLC(Highlight BLC)	ON / OFF		
Digital zoom	x2 - x256 (ZOOM / PAN / TILT)		
Mirror Image	V-FLIP / H-FLIP / HV-FLIP		
White blemish correction	Up to 64 pixels		
Function settings/Serial port	OSD (On Screen Display) / RS-485 (Pelco-D)		
Power Supply	DC+12V±10%		
Electric Power	1.62W (135mA)		
Operating Temperature	-10 ~ +50°C		
Operating Humidity	Less than 95% RH (Without condensation)		
Storage Temperature	-30 ~ +70°C		
Storage Humidity	Less than 95% RH (Without condensation)		
Lens Mount	CS-mount (Back focus adjustable)		
Size	43.5(W)×44(H)×67(D) (mm)		
Weight	Approx. 150g		

- Design and specifications are subject to change without notice.
- Watec is not responsible for any inconvenience or the attendant damages to the video and monitoring recording equipment caused by misuse, mis-operation or improper wiring of our equipment.
- If for any reason the WAT-233 does not work properly, or if you have any questions regarding installation or operation, please contact the distributor or dealer from which it was purchased.
- For details, please refer to the OSD Manual and H/W Manual available at <http://www.watec.co.jp/english/SoloPages/wat-233>.

关于电子信息产品污染控制标识

环境使用期限	名称	有害物质或元素						
		铅	镉	汞	六价铬	PBB	PBDE	
	外壳	○	○	○	○	○	○	
	电子零部件	○	○	○	○	○	○	
	电路板	○	○	○	○	○	○	
	附件	○	○	○	○	○	○	
	其它金属	×	○	○	○	○	○	

○:表示该有害物质在该部件所有均质材料中的含量的在SJ/T 11363-2006规定的限量要求以下。
 ×:表示该有害物质至少在该部件的某一均质材料中的含量超出SJ/T 11363-2006规定的限量要求。
 电鍍输入端子銅合金中含有4%以下的鉛。有無製造代用品的技术。

瓦楞紙板	LDPE	LDPE	PP
外包装箱	包装袋	气帽	附件袋

※生产日期位于包装的上面

A	A	年	记号	月	记号
		2011	A	1	1
年	月	2012	B	10	A

Contact information



Add.: 254-2 Nihonkoku, Daihoji, Tsuruoka- Shi, Yamagata-Ken, 997-0017 Japan
 TEL: +81-235-23-4400 FAX: +81-235-23-4409
 Email: info-o@watec.co.jp
 URL: <http://www.watec.co.jp>