

A811

4MP Outdoor Zoom Dome with D/N, Adaptive IR, Extreme WDR, SLLS, 5x Zoom Lens



- 4 Megapixel
- Day & Night with Superior Low Light Sensitivity and Adaptive IR LED
- Extreme WDR
- H.265 Compression
- Super wide angle
- Event trigger, response and notification

► Specifications

Device

Product Type	Zoom Dome
Maximum Resolution	4MP
Application Environment	Outdoor
Image Sensor	Progressive Scan CMOS
Sensor Size	1/2.7 "
Day / Night	Yes
Low Light Sensitivity	Superior
Minimum Illumination	Color: 0.01 lux; B/W: 0 lux (IR LED on)
Mechanical IR Cut Filter	Yes
IR LED	Adaptive IR LED (850 nm)
IR Working Distance	45m

Lens

Focal Length	Zoom, f2.7-13.5mm
Aperture	F1.6
Zoom Ratio	5x optical

Focus	Auto focus
Lens Mount	Board mount
Horizontal Viewing Angle	110° - 31°
Vertical Viewing Angle	58° - 18°
Viewing Angle Adjustment	Pan: 0°-355°, Tilt: 0°-75°, Rotation: 0°-355°

Video

Compression	H.265, H.264, MJPEG
Maximum Frame Rate vs. Resolution	30 fps at 2688 x 1520 30 fps at 2560 x 1440 30 fps at 2304 x 1296 30 fps at 1920 x 1080 30 fps at 1280 x 720 30 fps at 640 x 480 30 fps at 640 x 360 30 fps at 320 x 240
Multi-Streaming	Simultaneous quad streams
Bit Rate	32Kbps - 16Mbps (per stream)
Wide Dynamic Range	Extreme WDR (150 dB)
Image Enhancement	White Balance, Brightness, Contrast, Sharpness, Backlight compensation
Digital Noise Reduction	3D DNR
Privacy Mask	Yes
Built-in Analytics	Tampering Detection, Object Line Crossing Detection, Object Enter Area Detection, Object Loitering Detection
Image Orientation	Rotation

Audio

Audio Type	2-way, Mic-in, Line-in, Line-out
Audio Compression	G.711, G.722.1, G.726, MP2L2, PCM

Network

Network Protocol & Service	IPv4/v6, TCP, UDP, DHCP, PPPoE, HTTP, HTTPS, DNS, DDNS, NTP, RTP, RTSP, RTCP, SMTP, FTP, IGMP, ICMP, Bonjour, UPnP, QoS, SNMP, IEEE 802.1X
Ethernet Port	1 x Ethernet (10/100 Base-T), RJ-45 connector

Event

Event Trigger	Video motion detection, Tampering detection, Disk full, Disk not found,
---------------	---

Integration

ONVIF Compliant	Yes, Profile S, Profile G
-----------------	---------------------------

Interface

Audio Interface	Terminal block
Local Storage	MicroSD, MicroSDHC, MicroSDXC Memory Card Slot (card not included, up to 128GB)
Digital Input/Output	1/1 (Terminal block)

General

Power Source	DC 12V, PoE Class 3 (IEEE802.3af)
Power Consumption	10 W (DC), 12 W (PoE)
Weight	835g (1.8lb)

Dome Camera

Dimensions	(Ø x H): 153.3mm x 111.6mm (6.0" x 4.4")
Environmental Casing	Weatherproof (IP67), Vandal proof (IK10)
Operating Temperature	-30°C ~ 60°C (-22°F ~ 140°F)
Warranty	3 Year(s)

► Photo Indication



- 1 DC 12V Input
- 2 Ethernet Port
- 3 Reset Button
- 4 Memory Card Slot



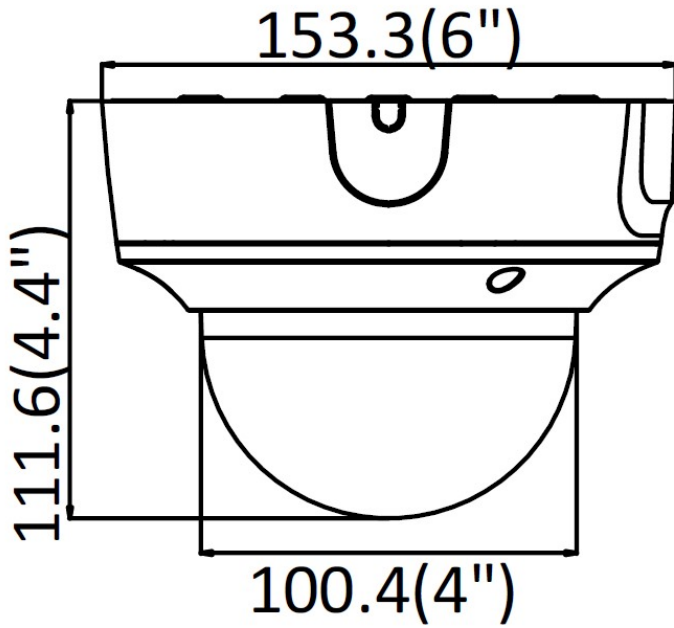















► Dimension Diagram











Unit: mm [inch]

▶ Related Products

Mounting Accessories - Camera Mount

PMAX-0102		Straight Tube
PMAX-0103		Straight Tube with Bracket
PMAX-0104		Extension Tube
PMAX-0114		Mount Kit for Dome Cameras (for A8x, except A88)
PMAX-0120		Straight Tube (for A811)
PMAX-0121		Straight Tube with Bracket (for A811)
PMAX-0124		Extension Tube (for A811)
PMAX-0302		Gooseneck with Bracket
PMAX-0303		Gooseneck
PMAX-0321		Heavy Duty Wall Mount for Outdoor Domes (for A8x, except A88)
PMAX-0326		Gooseneck (for PMAx-0114)
PMAX-0327		Gooseneck with Bracket (for PMAx-0114)
PMAX-0402		Corner Mount
PMAX-0406		Corner Mount (for PMAx-0321, PMAx-0326, PMAx-0717)
PMAX-0503		Pole Mount (for PMAx-0102, PMAx-0312, PMAx-0313, PMAx-0314, PMAx-0702, PMAx-1106, PMAx-1107), supports 5.25" to 8.5" Poles
PMAX-0505		Pole Mount (for B4x, B41x, E44, E45, E46, E48, E44A, E45A, E46A, E41x, I4x, PMAx-0312, PMAx-0313, PMAx-0314, PMAx-0330), supports 2" to 3" Poles
PMAX-0521		Pole Mount (White) , supports 5.25" to 8.5" Poles
PMAX-0522		Pole Mount (White) , supports 2" to 3" Poles

PMAX-0702		Junction Box for PTZ and Dome Cameras
PMAX-0717		Junction Box for PTZ and Dome Cameras
PMAX-0722		Junction Box (for A811, A813, A818)
PMAX-0807		Gangbox Converter (for PMA-0102, PMA-0312, PMA-0313, PMA-0314, PMA-0321), supports Two-Gang Boxes
PMAX-0808		Converter Ring, 1.5" NPT for Third-Party Mounting Accessories
PMAX-0815		Gangbox Converter (for PMA-0102, PMA-0312, PMA-0313, PMA-0314, PMA-0321) , supports Two-Gang Boxes
PMAX-0817		Converter Ring, 1.5" NPT for Third-Party Mounting Accessories
PMAX-1030		Flush Mount (for A811, A813, A818)

Note: Some mounting accessories may need additional accessories for installation. Please check www.acti.com/mountingselector for more information.