

Q115

5MP with Basic WDR, Fixed Lens



- 5 Megapixel
- Fixed Lens with f3.7mm/F2.5
- Basic WDR
- Easy-to-Install for mounting solutions
- Event trigger, response and notification

► Specifications

Device

Product Type	L-Shape Pinhole Covert
Maximum Resolution	5MP
Application Environment	Indoor
Image Sensor	Progressive Scan CMOS
Sensor Size	1/3.2 "
Effective Pixels	2592(H) X 1944(V) (5.04 MP)
Day / Night	No
Low Light Sensitivity	Standard
Minimum Illumination	Color: 0.1 lux at F2.5 (30 IRE, 2400 K)
Mechanical IR Cut Filter	No
IR LED	No
Horizontal Resolution (TV Lines)	1350 TVL
S/N Ratio	52 dB

Lens

Focal Length	Fixed focal, f3.7mm
Aperture	F2.5

Iris	Fixed iris
Focus	Fixed focus
Lens Mount	RJ12 connector up to 12m from main unit
Horizontal Viewing Angle	70.2°
Vertical Viewing Angle	51.4°

Video

Compression	H.264 (Baseline/ Main/ High profile), MJPEG
Maximum Frame Rate vs. Resolution	15 fps at 2592 x 1944 15 fps at 2048 x 1536 30 fps at 1920 x 1080 30 fps at 1280 x 720 30 fps at 800 x 600 30 fps at 640 x 480 15 fps at 320 x 240
Multi-Streaming	Simultaneous dual streams based on two configurations
Bit Rate	28Kbps - 6Mbps (per stream)
Bit Rate Mode	Constant, Variable
Wide Dynamic Range	Basic WDR (74 dB)
Digital Noise Reduction	DNR
Privacy Mask	4 configurable regions
On-Screen Graphics	Yes
Server-based Analytics	Object Line Counting, People Counting, Face Detection, Object Based Motion Detection, Tamper, Object Line Crossing Detection, Object Enter Area Detection, Missing Object Detection, Unattended Object Detection, Smoke Detection, Heat Map, Dwell Time, People Queue Detection, (Require PC-based or standalone IVS or ALPR Server. Contact ACTi support for recommendations on how to maximize analytical accuracy)

Audio

Audio Type	2-way, Mic-in, Line-in, Line-out
Audio Compression	8 kHz, 16 bit encoding, Mono, PCM, G.711

Network

Network Protocol & Service	IPv4/v6, TCP, UDP, DHCP, PPPoE, HTTP, HTTPS, DNS, DDNS, NTP, RTP, RTSP, RTCP, SMTP, FTP, IGMP, ICMP, ARP, Bonjour, UPnP, QoS, SNMP, IEEE 802.1X
Ethernet Port	1 x RJ-45 connector
Security	IP address filtering, HTTPS encryption, Password protected user level, Anonymous login, IEEE 802.1X network access control

Event

Event Trigger	Video motion detection (3 regions), External device through digital input, Sound detection,
Event Response	Notify control center, Change camera settings, Command other devices, E-mail notification with snapshots, Play the audio file, Push notification to mobile device, Save video to local storage, Upload video or snapshot to FTP server, Upload video to NVR server, Activate external device through digital output

Integration

Unified Solution	Fully compatible with ACTi software
GPS Position	Manual setting
ONVIF Compliant	Yes, Profile S, Profile G, Profile Q
GB28181 Compliant	Yes

Web Browser	IE 11
Auto Firmware Upgrade	Yes

Interface

Serial Port	1 x RS-232
Local Storage	MicroSDHC, MicroSDXC memory card slot (card not included)
Digital Input/Output	1/1

General

Power Source	DC 12V, PoE Class 2 (IEEE802.3af)
Power Consumption	4.32 W (PoE)
Weight	510g (1.124lb)
Dimensions	Main Unit (W x H x D): 75mm x 100.33mm x 30mm (3.0" x 4.0" x 1.2") Lens Unit (W x H x D): 22mm x 32mm x 21.22mm (0.9" x 1.3" x 0.8")
Environmental Casing	Vibration proof (EN50155)
Mount Type	Surface, Tilttable Surface Mount, Flush, Tilted Mount, Height Strip, Bracket
Starting Temperature	-20°C ~ 50°C (-4°F ~ 122°F)
Operating Temperature	-30°C ~ 60°C (-22°F ~ 140°F)
Approvals	CE, FCC, EN50155, UL (for optional PoE injector and power adapter)
Warranty	3 Year(s). For extended warranty offering, see http://www.acti.com/support/warranty

▶ Photo Indication



- 1 LED Indicators
- 2 Memory Card Slot
- 3 Digital Input/Output
- 4 Camera Input
- 5 Audio-In/Audio-Out
- 6 Ethernet Port
- 7 Serial Port
- 8 DC 12V Power Input
- 9 Reset Button



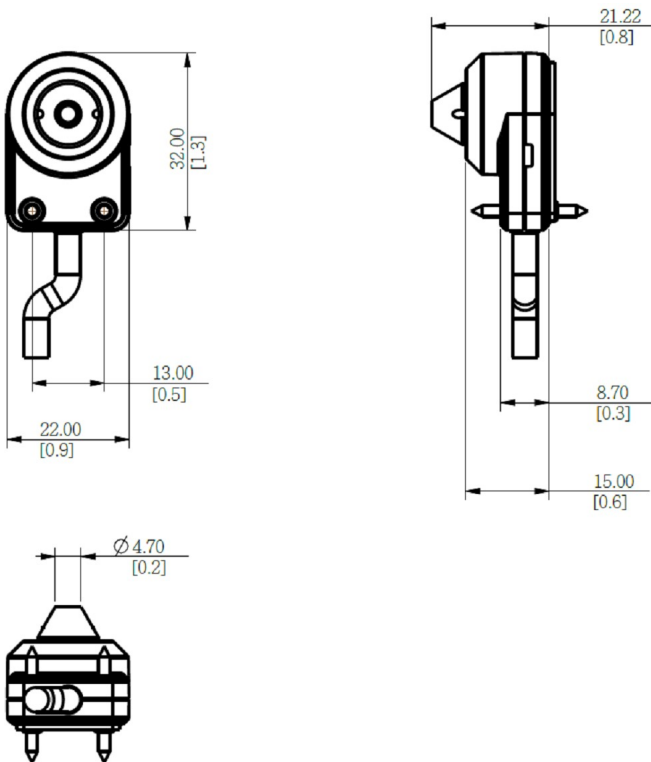







▶ Dimension Diagram



Unit: mm [inch]

► Related Products

Mounting Accessories - Camera Mount





PMAX-0331		Height Strip Mount (Silver) for L-Shape Pinhole Covert Cameras
PMAX-0332		Height Strip Mount (Bronze) for L-Shape Pinhole Covert Cameras
PMAX-0334		Tiltable Surface Mount for L-Shape Pinhole Covert Cameras
PMAX-0335		Tilt Wedge (Silver) for PMAX-0331
PMAX-0336		Tilt Wedge (Bronze) for PMAX-0332
PMAX-1109		Windshield Mounting Bracket for L-Shape Pinhole Covert Cameras
R707-A0004		Bundled Surface Mount for L-Shape Pinhole Covert Camera
R707-A0005		Bundled Tilted Mount for L-Shape Pinhole Covert Camera
R707-A0006		Bundled Flush Mount for L-Shape Pinhole Covert Camera
R707-A0007		Bundled Mounting Rail Kit for Covert Camera

Note: Some mounting accessories may need additional accessories for installation. Please check www.acti.com/mountingselector for more information.

Power Supply Accessories - Power Adapter

PPBX-0011		Power Adapter AC 100~240V, with universal connectors for all DC12V powered devices
-----------	---	--

Network & Storage Peripherals - Data Switch

PPSW-0100		PLANET FGSD-910HP 8-Port 802.3at PoE Switch (PoE Budget 120W)
PPSW-0101		PLANET GS-4210-8P2T2S 8-Port Gigabit 802.3at Managed PoE Switch (PoE Budget 240W)
PPSW-0102		PLANET FGSD-1011HP 8-Port 802.3at PoE Switch (PoE Budget 120W)
PPSW-1101		PLANET GS-4210-24PL4C 24-Port Gigabit 802.3at Managed PoE Switch (PoE Budget 440W)
PPSW-3100		PLANET FGSW-1816HPS 16-Port 802.3at PoE Switch (PoE Budget 220W)

Extenders - PoE Extender

PPEX-0100  Veracity OUTREACH Max Power over Ethernet (PoE) Extender

Extenders - PoE over Coaxial Extender Kit

PPOC-0100  Planet LRP-101C-KIT Power over Coax Adapter Kit

Audio Devices - Microphone

PMIC-0100  Active Microphone Omnidirectional for all Cameras with Line-in Audio

PMIC-0201  Passive Microphone Omnidirectional for all Cameras with Mic-In Audio using Cable Wire or Terminal Connector, 2m cable

Installation Support - Camera Installation Kit

PMON-1001-010  Camera Installation Kit for use with iOS Device with belt bag, battery and charger (US, AC 110~240V)

PMON-1001-011  Camera Installation Kit for use with iOS Device with belt bag, battery and charger (Europe, AC 110~240V)

PMON-2000  Camera Installation Kit