

A950

8MP Outdoor Speed Dome with D/N, Adaptive IR, Extreme WDR, ELLS, 22x Zoom Lens



- 8 Megapixel with 4K Ultra HD
- Day & Night with Extreme Low Light Sensitivity and Adaptive IR LED
- Extreme WDR
- Endless Pan & Tilt
- H.265 Compression

► Specifications

Device

Product Type	Speed Dome
Maximum Resolution	8MP
Application Environment	Outdoor
Image Sensor	Progressive Scan CMOS
Sensor Size	1/1.8 "
Effective Pixels	3864(H) X 2180(V) (8.42 MP)
Day / Night	Yes
Low Light Sensitivity	Extreme
Mechanical IR Cut Filter	Yes
IR LED	Adaptive IR LED
IR Working Distance	100m

Lens

Focal Length	Zoom, f6.4-138.5mm
Aperture	F1.5
Zoom Ratio	22x optical zoom

Iris	DC iris
Focus	Auto focus
Lens Mount	Board mount
Horizontal Viewing Angle	59.8° - 3°

PTZ

Manual Panning / Tilting Speed	0.1° - 90°/second, 0.1° - 60°/second
Preset Panning / Tilting Speed	5° - 280°/second, 5° - 280°/second
Panning Range	360° endless
Tilting Range	-20°~200°
PTZ Control	PTZ Control, Speed Control, Auto scan, 256 preset points
Preset Accuracy (Panning/Tilting)	5°/280°, 5°/280°

Video

Compression	H.265, H.264, MJPEG
Maximum Frame Rate vs. Resolution	30 fps at 3840 x 2160 (4K Ultra HD) 30 fps at 3200 x 1800 30 fps at 1920 x 1080 30 fps at 1280 x 1024 30 fps at 1280 x 720 30 fps at 800 x 600 30 fps at 720 x 480 30 fps at 640 x 480 30 fps at 352 x 240 30 fps at 320 x 240
Multi-Streaming	Quad streams
Wide Dynamic Range	Extreme WDR (120 dB)
Image Enhancement	Gyro-based Image Stabilizer
Digital Noise Reduction	2D + 3D DNR
Privacy Mask	Yes
Text Overlay	Yes
Built-in Analytics	Object Based Motion Detection
Image Orientation	Flip, Mirror

Network

Ethernet Port	1 x Ethernet (10/100 Base-T), RJ-45 connector Network Cable: all 4 pairs of standard Cat 5e or higher Ethernet cable
---------------	--

Integration

ONVIF Compliant	Yes, Profile S, Profile G, Profile T
-----------------	--------------------------------------

Interface

Local Storage	MicroSD, MicroSDHC, MicroSDXC Memory Card Slot (card not included, microSD to SD Memory Card Adapter is required.)
Digital Input/Output	4/2
Operating Button	Reset Button

General

Power Source	AC 24V 3A, High PoE 60W
Power Consumption	High PoE: Max. 46.20W (by using all 4 pairs of standard Cat 5e or higher Ethernet cable), AC: Max. 52.80W, 71.50VA

Weight	4155g (9.16lb)
Dimensions	(Ø x H): 207.4mm x 300.4mm (8.17" x 11.83")
Environmental Casing	Weatherproof (IP66)
Bundled Accessories	High PoE injector
Mount Type	Wall Mount, Ceiling Bracket, Pendant, Corner Mount, Pole Mount, Converter for NPT Standard Mounts
Heater	Yes
Operating Temperature	-40°C ~ 50°C (-40°F ~ 122°F)
Approvals	CE Class A, FCC Class A, IP66
Real-time Clock (RTC)	Yes
Warranty	3 Year(s) (1 year in continuous motion). For extended warranty offering, see http://www.acti.com/support/warranty

▶ Photo Indication

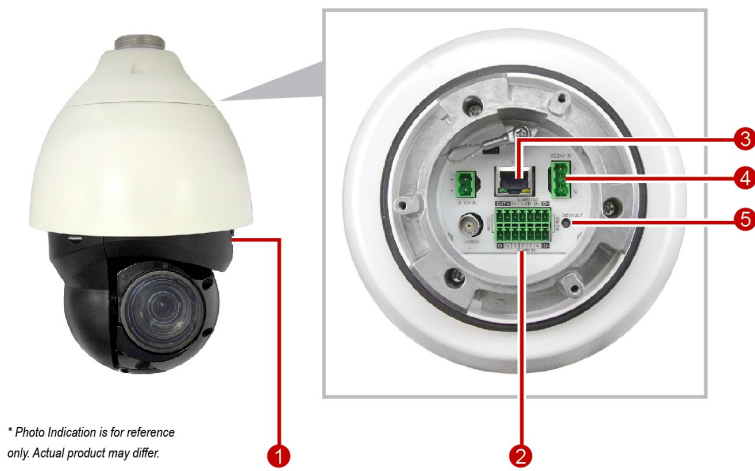

- 1 Memory Card Slot
- 2 Digital Input/Output & Serial Port Connector
- 3 Ethernet Port
- 4 AC24V Power Input
- 5 Reset Button

** Photo Indication is for reference only. Actual product may differ.*



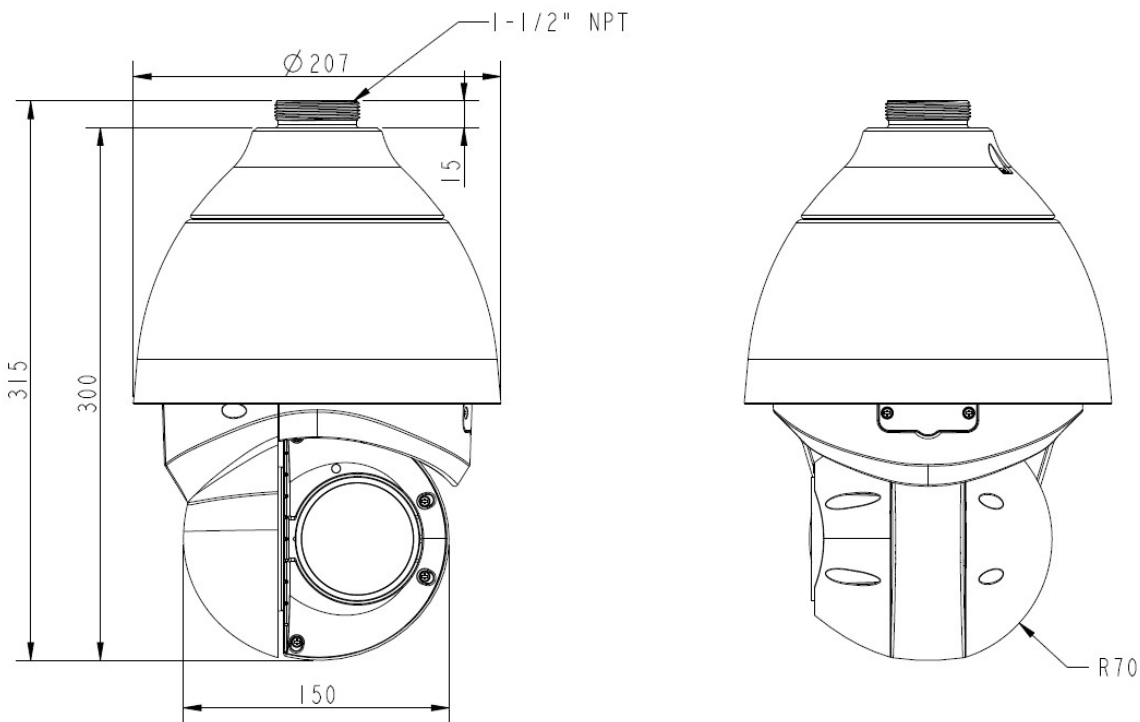



▶ Dimension Diagram



Unit: mm [inch]



▶ Related Products

Mounting Accessories - Camera Mount

PMAX-0115		Pendant Mount (for A951, Z950, Z952)
PMAX-0324		Wall Mount (for A950)
PMAX-0346		Heavy Duty Wall Mount for A951
PMAX-0402		Corner Mount
PMAX-0514		Pole Mount (for A950)
PMAX-0531		Pole mount for A951

Note: Some mounting accessories may need additional accessories for installation. Please check www.acti.com/mountingselector for more information.

Power Supply Accessories - PoE Injector

PPOE-0103		High PoE Injector, Single-port, 60W Gigabit Midspan, 4-Pairs, 802.3at Compliant, AC 100~240V, with universal connectors (for, I93~I910, I915, B915~B917, B922, B928, B945, B949, A950, A951)
PPOE-0104		High PoE Injector, Single-port, 10/100/1000Mbps 60W, 4-Pairs, 802.3at Compliant, AC 100~240V, with universal connectors (for, I93~I910, I915, B915~B917, B922, B928, B945, B949, A950, A951)