

# PRODUCT



MEGA FLOOD LIGHT  
T600 SERIES  
240W/300W



ULTRA FLOOD LIGHT  
T500 SERIES  
480W-1440W

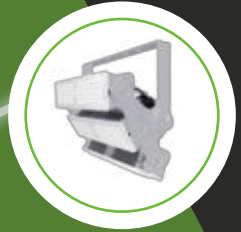

LED FLOOD LIGHT  
T400 SERIES  
60W-600W



SOLAR LIGHT  
S300 SERIES



LED HIGH BAY LIGHT  
HALO SERIES  
50W-240W



LED HIGH BAY LIGHT  
4BAY SERIES  
100W-480W



LED STREET LIGHT  
L500 SERIES  
50W-200W



LED STREET LIGHT  
T400L SERIES/  
LED LINEAR LIGHT  
X300 SERIES

# G-COMIN

Innovative LED Light Manufacturer



SHENZHEN COMING TECHNOLOGY CO.,LTD

+86-755-28462760

info@co-ming.com

www.co-ming.com

Coming Industrial Park  
Longgang District  
Shenzhen China

# Mega Flood Light T600



## CO-T600-240W

180LM/W±5%  
43,200LM±5%  
5.5kg±5%

## CO-T600-300W

170LM/W±5%  
51,000LM±5%  
6.0kg±5%



## Specifications

WATTAGE	240/300W
CRI	Ra>70/80
CCT	2700-6500K
RATED VOLTAGE	AC 100-240V 277V~, 50/60Hz
POWER FACTOR	>0.95
IP GRADE	IP66
IK GRADE	IK10
BEAM ANGLE	30°/60°/90°, Asymmetric G4
OPERATING TEMP	-40°C~60°C
SIZE	344x184x238mm

## Accessories

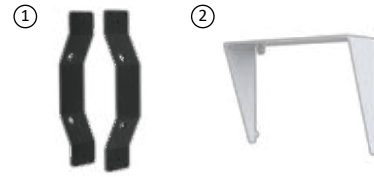

Laser Pointer



Lightning Arrester  
(20KV)

Single Module 240W,300W



Two Modules 480W,540W,600W

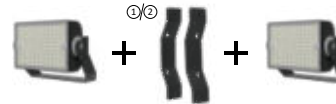

Three Modules 720W,780W,840W,900W





## Feature

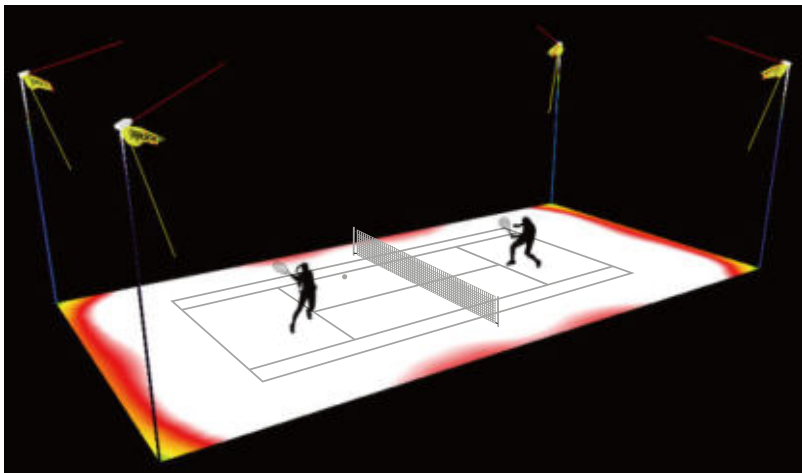

- ▶ Asymmetrical G4 light distribution, especially for tennis court project.



# 180LM/W

A standard tennis court requires only 4pcs CO-T600 to achieve the uniformity of 0.85 or more.

# Ultra Flood Light T500



CO-T500-480W

84,000LM±5%  
12.0kg±5%  
536×165×579mm



CO-T500-720W

126,000LM±5%  
16.0kg±5%  
691×202×579mm



CO-T500-960W

168,000LM±5%  
19.6kg±5%  
846×202×579mm



CO-T500-1200W

210,000LM±5%  
24.0kg±5%  
1001×277×579mm



CO-T500-1440W

252,000LM±5%  
28.0kg±5%  
1156×277×579mm

## Specifications

WATTAGE	480/720/960/1200/1440W
CRI	Ra>70/80
CCT	2700-6500K
RATED VOLTAGE	AC 100-240V 277V~, 50/60Hz
POWER FACTOR	>0.95
IP GRADE	IP66
HEAT-SINK	ALUMINIUM COOLING FIN
OPERATING TEMP	-40°C~60°C

LAMP EFFICIENCY	175LM/W±5%	165LM/W±5%	120LM/W±5%
BEAM ANGLE	60°/90°/120°	30°	10°

## Detail Pictures

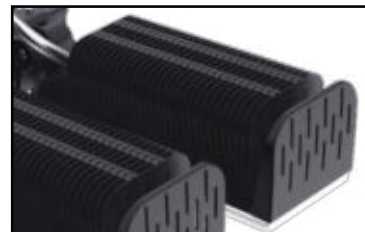





Optional Laser Pointer Device

Double Bracket

Rotatable Module Design

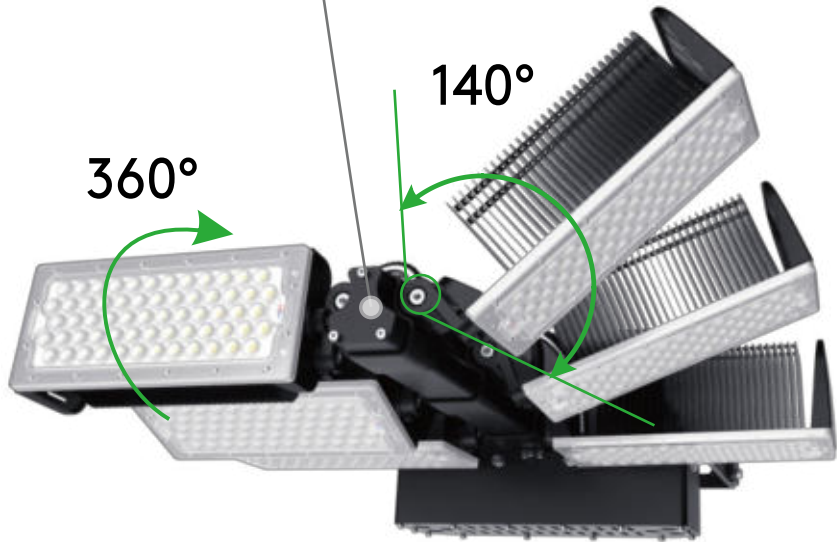

360°

140°



175LM/W

There are more than 50,000 stadiums in the world. Those sports fields not illuminated by G-COMIN provide us with our mission incentive.

# LED Flood Light T400

## CO-T400A-100W

17,000LM±5%  
2.9kg±5%  
291×102×266mm



## CO-T400B-60W

10,200LM±5%  
2.4kg±5%  
291×102×266mm

## CO-T400A-200W

34,000LM±5%  
4.2kg±5%  
291×219×334mm



## CO-T400B-120W

20,400LM±5%  
3.8kg±5%  
291×219×334mm

## CO-T400A-300W

51,000LM±5%  
5.6kg±5%  
291×340×324mm



## CO-T400B-180W

30,600LM±5%  
4.7kg±5%  
291×340×324mm

## CO-T400A-400W

68,000LM±5%  
7.4kg±5%  
485×219×334mm



## CO-T400B-240W

40,800LM±5%  
5.9kg±5%  
485×219×334mm

## CO-T400A-600W

102,000LM±5%  
10.3kg±5%  
485×340×324mm



## CO-T400B-360W

61,200LM±5%  
8.6kg±5%  
485×340×324mm

## Specifications

WATTAGE	60/120/180/240/360W 100/200/300/400/600W
CRI	Ra>70/80
CCT	2700-6500K
RATED VOLTAGE	AC 100-240V 277V~, 50/60Hz
POWER FACTOR	>0.95
IP GRADE	IP65
HEAT-SINK	ALUMINIUM COOLING FIN
OPERATING TEMP	-40°C~60°C

	60°/90°/120°	30°	10°
T400A	170LM/W±5%	160LM/W±5%	120LM/W±5%
T400B	170LM/W±5%	160LM/W±5%	120LM/W±5%

## Contrast

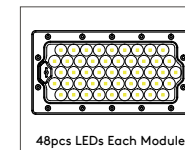
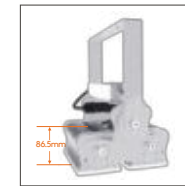

T400A

VS

T400B

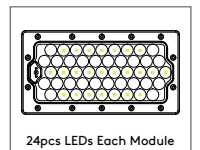
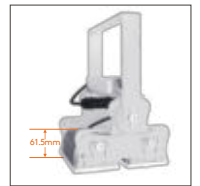

LED Quantity

Heat-Sink

## Feature

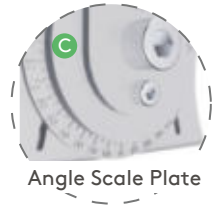
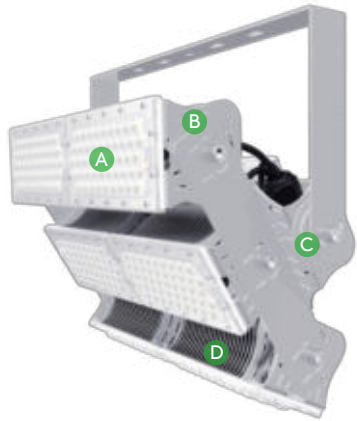

## Adjustable Function

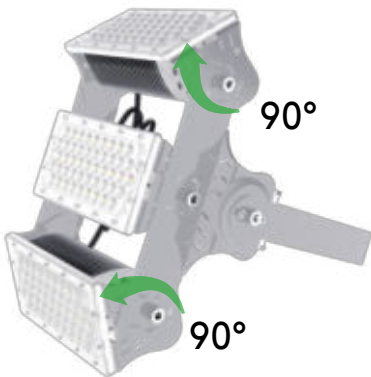

Rotatable Module



360° Rotatable Holder



# 170LM/W

This 97m tower was every inch the pride of its creators and we've made it even more elegant.



# LED Flood Light T300A



WATTAGE	75/150/240W
LAMP EFFICIENCY	150LM/W±5%
CRI	Ra>70/80
CCT	2700-6500K
RATED VOLTAGE	AC 100-240V 277V~, 50/60Hz
POWER FACTOR	>0.95
BEAM ANGLE	45°/75°/120°
IP GRADE	IP65
HEAT SINK	ALUMINIUM COOLING FIN
OPERATING TEMP	-40°C~60°C

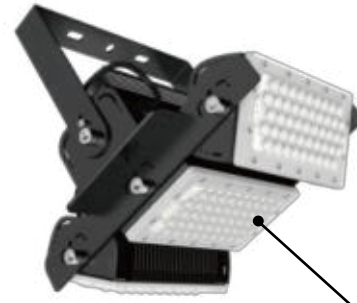

Multiple optical lens choices are available with angles including 45°/75°/120°



## Rotatable module



**CO-T300A-75W**

11,250LM±5%  
2.1kg±5%  
237×102×162mm



**CO-T300A-150W**

22,500LM±5%  
3.5kg±5%  
295×210×274mm



**CO-T300A-240W**

36,000LM±5%  
5.0kg±5%  
295×319×274mm

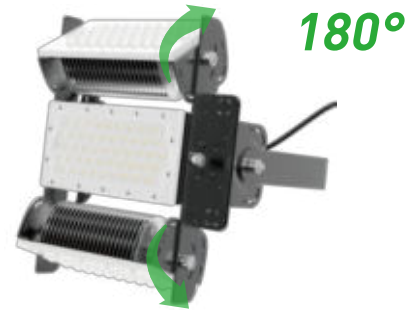

Module rotatable 180°

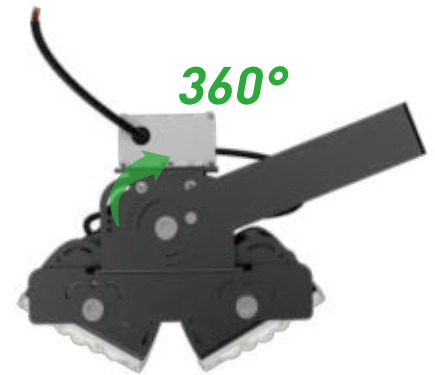

Arc bracket rotatable 360°

## Feature



◀ Bracket scale

Module scale ▶





# LED Flood Light F300



**CO-F300-240W**

34,800LM±5%  
3.5kg±5%  
306x156x225mm



**CO-F300-480W**

69,600LM±5%  
7.0kg±5%  
306x334x225mm

1 LED Modules(240W)

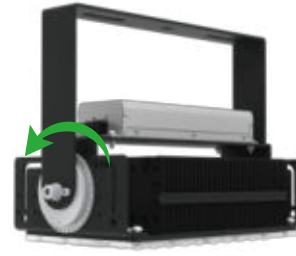

360° Rotatable Holder

2 LED Modules(480W)



295° Rotatable Holder

## Specifications

WATTAGE	240/480W
LAMP EFFICIENCY	145LM/W±5%
CRI	Ra>70/80
CCT	2700-6500K
RATED VOLTAGE	AC 100-240V 277V~, 50/60Hz
POWER FACTOR	>0.95
BEAM ANGLE	30°/60°/90°
IP GRADE	IP66
IK GRADE	IK10
OPERATING TEMP	-40°C~50°C

## Feature



High Transparency Lens  
(30°/60°/90°)



Accessories-Light Shield

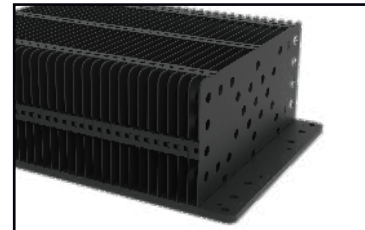

High Efficient Heatsink



Angle Scale Plate

# High Bay Light HALO



## CO-HALO-30W

4,950LM±5%  
3.2kg±5%  
φ380x63mm

## CO-HALO-50W

8,250LM±5%  
3.2kg±5%  
φ380x63mm

## CO-HALO-80W

13,200LM±5%  
3.6kg±5%  
φ380x63mm

## CO-HALO-100W

16,500LM±5%  
3.8kg±5%  
φ380x63mm

## CO-HALO-150W

24,750LM±5%  
3.8kg±5%  
φ380x63mm

## CO-HALO-200W

33,000LM±5%  
5.6kg±5%  
φ500x68mm

## CO-HALO-240W

39,600LM±5%  
5.6kg±5%  
φ500x68mm

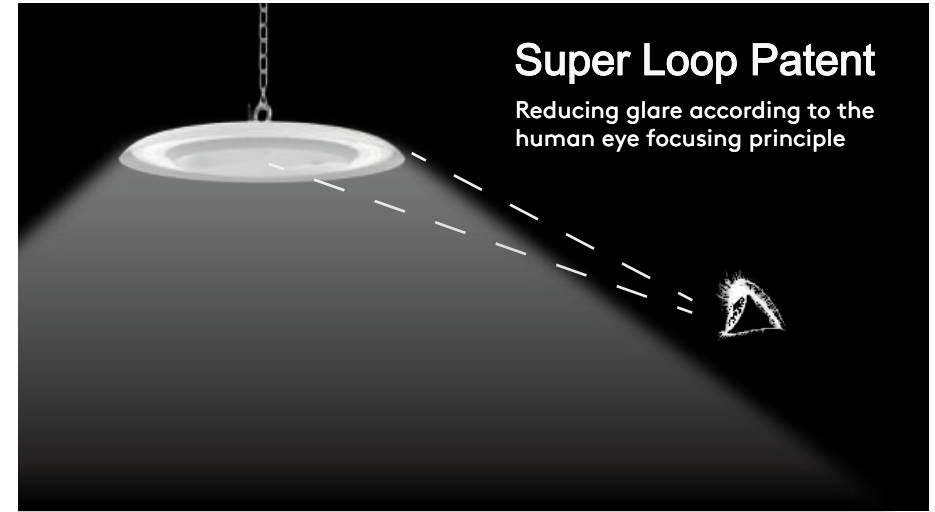

► IP66 & nano-coating, minimize maintenance cost.

► Compact curved surface design, too smooth to gather dirt.



## Specifications

WATTAGE	30/50/80/100/150/200/240W
LAMP EFFICIENCY	165LM/W±5%
CRI	Ra>70/80
CCT	2700-6500K
RATED VOLTAGE	AC 100-240V 277V~, 50/60Hz
POWER FACTOR	>0.95
BEAM ANGLE	60°/90°/120°
IP GRADE	IP66
IK GRADE	IK10
OPERATING TEMP	-40°C~55°C

# Food Processing Light HALO-F



## CO-HALO-F30W

4,950LM±5%  
3.2kg±5%  
ø380x63mm

## CO-HALO-F50W

8,250LM±5%  
3.2kg±5%  
ø380x63mm

## CO-HALO-F80W

13,200LM±5%  
3.6kg±5%  
ø380x63mm

## CO-HALO-F100W

16,500LM±5%  
3.8kg±5%  
ø380x63mm

## CO-HALO-F150W

24,750LM±5%  
3.8kg±5%  
ø380x63mm

## CO-HALO-F200W

33,000LM±5%  
5.6kg±5%  
ø500x68mm

## CO-HALO-F240W

39,600LM±5%  
5.6kg±5%  
ø500x68mm

## Specifications

WATTAGE	30/50/80/100/150/200/240W
LAMP EFFICIENCY	165LM/W±5%
CRI	Ra>70/80
CCT	2700-6500K
RATED VOLTAGE	AC 100-240V 277V~, 50/60Hz
POWER FACTOR	>0.95
BEAM ANGLE	60°/90°/120°
IP GRADE	IP69K
IK GRADE	IK10
OPERATING TEMP	-40°C~55°C



## Safety guarantee

No toxic chemicals - NSF+LFGB+ROHS approved.

No water/steam/dust ingress - IP69K protection.

No dangerous parts - PC lens & integrated design, prevent parts from falling even under impact.



# LED High Bay Light 4BAY

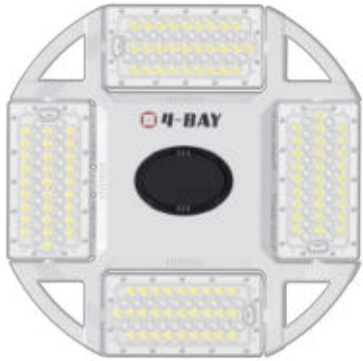

WATTAGE	100/150/200/240/300/400/480W
LAMP EFFICIENCY	160LM/W±5%
CRI	Ra>70/80
CCT	2700-6500K
RATED VOLTAGE	AC 100-240V 277V~, 50/60Hz
POWER FACTOR	>0.95
BEAM ANGLE	60°/120° (100/150/200/240W) 30°/60°/90°/120° (300/400/480W)
IP GRADE	IP65
HEAT SINK	ALUMINIUM COOLING FIN ALUMINIUM RIVET
OPERATING TEMP	-40°C~60°C



**CO-4BAY-100W**  
16,000LM±5%  
4.5kg±5%  
429×429×159mm

**CO-4BAY-150W**  
24,000LM±5%  
4.5kg±5%  
429×429×159mm



**CO-4BAY-200W**  
32,000LM±5%  
5.3kg±5%  
429×429×159mm

**CO-4BAY-240W**  
38,400LM±5%  
5.3kg±5%  
429×429×159mm



**CO-4BAY-300W**  
48,000LM±5%  
7.1kg±5%  
429×429×225mm

**CO-4BAY-400W**  
64,000LM±5%  
7.4kg±5%  
429×429×225mm

**CO-4BAY-480W**  
76,800LM±5%  
7.4kg±5%  
429×429×225mm

## Feature



- Ultralight
- Module Adjustable Toolless
- Module Rotatable 200°

- Build-In Sensor Available
- High Luminous Flux
- Installation & Maintenance Friendly



## Original Design Heat-Sink



100/150W  
Aluminium Rivet



200/240W  
Aluminium Cooling Fin



300/400/480W  
Aluminium Cooling Fin

# LED Post Top Light HALO-L



WATTAGE	30/50/80/100/150/200/240W
LAMP EFFICIENCY	165LM/W±5%
CRI	Ra>70/80
CCT	2700-6500K
RATED VOLTAGE	AC 100-240V 277V~, 50/60Hz
POWER FACTOR	>0.95
BEAM ANGLE	60°/90°/120°
IP GRADE	IP66
IK GRADE	IK10
OPERATING TEMP	-40°C~60°C
SPIGOT DIAMETER	60/80mm

## CO-HALO-L30W

4,950LM±5%  
3.6kg±5%  
ø380x162mm

## CO-HALO-L50W

8,250LM±5%  
3.6kg±5%  
ø380x162mm

## CO-HALO-L80W

13,200LM±5%  
4.0kg±5%  
ø380x162mm

## CO-HALO-L100W

16,500LM±5%  
4.1kg±5%  
ø380x162mm

## CO-HALO-L150W

24,750LM±5%  
4.2kg±5%  
ø380x162mm

## CO-HALO-L200W

33,000LM±5%  
6.0kg±5%  
ø500x168mm

## CO-HALO-L240W

39,600LM±5%  
6.0kg±5%  
ø500x168mm

Unique appearance, stylish decoration for your public space.

Annular luminous surface, efficient and comfortable lighting.

All aluminium body resists corrosion and ages well.

Smooth curve surface gathers no dirt/leaf/snow/ice, self-cleaning with the assistants of wind and rain.

# IP66 & IK10

# LED Street Light L500



## CO-L500-30W

4,950LM±5%  
4.6kg±5%  
478x238x250mm

## CO-L500-50W

8,250LM±5%  
4.6kg±5%  
478x238x250mm

## CO-L500-80W

13,200LM±5%  
4.6kg±5%  
478x238x250mm

## CO-L500-100W

16,500LM±5%  
4.7kg±5%  
478x238x250mm

## CO-L500-150W

24,750LM±5%  
5.7kg±5%  
531x283x267mm

## CO-L500-200W

33,000LM±5%  
5.8kg±5%  
531x283x267mm

## Specifications

WATTAGE	30/50/80/100/150/200W
LAMP EFFICIENCY	165LM/W±5%
CRI	Ra>70/80
CCT	2700-6500K
RATED VOLTAGE	AC 100-240V 277V~, 50/60Hz
POWER FACTOR	>0.95
IP GRADE	IP66
IK GRADE	IK10
BEAM ANGLE	Asymmetric G7/G7-FT/G7-UW
OPERATING TEMP	-40°C~60°C

## Integrated Surface

You won't see any exposed screw on the smooth lamp body, leave no place for dirt, leaf, snow, sand or even birds droppings.  
7.8mm at its thinnest point, a neat modern artwork.



## Feature



180° adjustable pole spigot/wall bracket with scale

## Installation



Pole



Arm



Wall



# LED Street Light L300



**CO-L300-60W**

8,400LM±5%  
3.7kg±5%  
81×271×437.5mm



**CO-L300-120W**

16,800LM±5%  
4.9kg±5%  
81×271×547.5mm



**CO-L300-180W**

25,200LM±5%  
5.8kg±5%  
81×271×657.5mm



**CO-L300-240W**

33,600LM±5%  
6.8kg±5%  
81×271×767.5mm

## Specifications

WATTAGE	60/120/180/240W
LAMP EFFICIENCY	140LM/W±5%
CRI	Ra>70/80
CCT	2700-6500K
RATED VOLTAGE	AC 100-240V 277V~, 50/60Hz
POWER FACTOR	>0.95
BEAM ANGLE	X-135°,Y-65°
IP GRADE	IP66
HEAT-SINK	ALUMINIUM COOLING FIN
OPERATING TEMP	-40°C~60°C
SPIGOT DIAMETER	64mm

## Feature



Adjustable high strength bracket to suit various pole types and diameters.

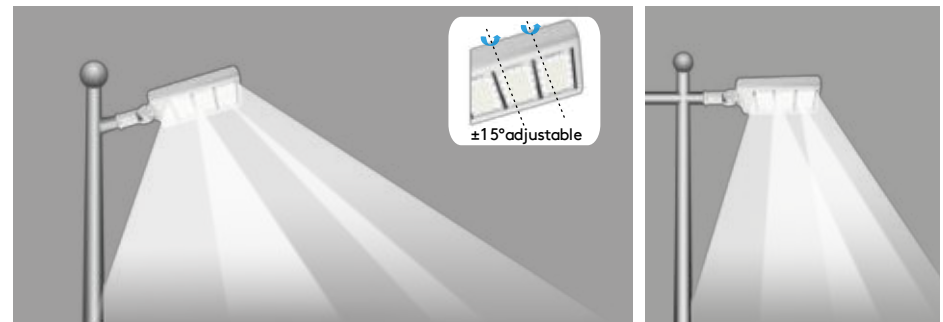

Each module is rotatable allowing easy adjustment to suit different road widths.

# LED Street Light T400L



CO-T400L-120W

20,400LM±5%  
4.4kg±5%  
478×220×169mm

CO-T400L-200W

34,000LM±5%  
4.6kg±5%  
478×220×169mm



CO-T400L-180W

30,600LM±5%  
5.5kg±5%  
478×338×169mm

CO-T400L-300W

51,000LM±5%  
6.3kg±5%  
478×338×169mm



CO-T400L-240W

40,800LM±5%  
6.2kg±5%  
670×221×205mm

CO-T400L-400W

68,000LM±5%  
7.8kg±5%  
670×221×205mm



CO-L307-30W

4,200LM±5%  
1.4kg±5%  
307×124×99mm



CO-L307-40W

5,200LM±5%  
1.4kg±5%  
307×124×99mm

## Specifications

LAMP EFFICIENCY	CRI	CCT	BEAM ANGLE
170LM/W±5% (60°/90°/120°) 160LM/W±5% (30°) 120LM/W±5% (10°)	Ra>70/80	2700-6500K	10°/30°/60°/90°/120°
POWER FACTOR	SPIGOT DIAMETER	IP GRADE	OPERATING TEMP
>0.95	60mm	IP65	-40°C~60°C
HEAT-SINK		RATED VOLTAGE	
ALUMINIUM COOLING FIN		AC 100-240V 277V~, 50/60Hz	

## Feature

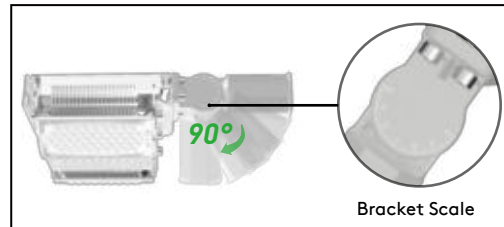

# LED Street Light L307

WATTAGE	30/40W
LAMP LUMINOUS FLUX	130-140LM/W±5%
CRI	Ra>80
CCT	2700-6500K
RATED VOLTAGE	AC 90-305V, 50/60Hz
POWER FACTOR	>0.95
BEAM ANGLE	X-120°, Y-60°
IP GRADE	IP65
HEAT-SINK	ALUMINIUM COOLING FIN
OPERATING TEMP	-40°C~60°C

# LED Bulkhead Light B300



## CO-B300-30W

4,650LM±5%  
1.2kg±5%  
250x107.4x84mm

## CO-B300-50W

7,750LM±5%  
1.2kg±5%  
250x107.4x84mm

## Specifications

WATTAGE	30/50W
LAMP LUMINOUS FLUX	155LM/W±5%
CRI	Ra>70/80
CCT	2700-6500K
RATED VOLTAGE	AC 100-240V 277V~, 50/60Hz
POWER FACTOR	>0.95
IP GRADE	IP66
IK GRADE	IK10
BEAM ANGLE	Asymmetric G5
OPERATING TEMP	-40°C~60°C

## Light Distribution

Asymmetric G5

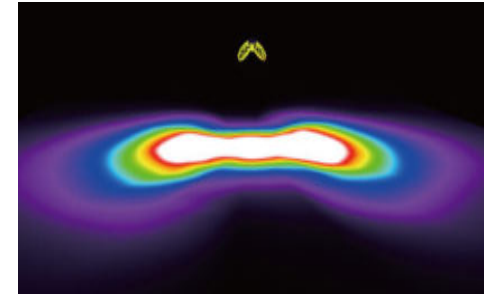

Mining Industry



Conveyor Belt



## Installation



Ceiling installation



Wall mounting



Suspension installation



# LED Wall Light W300



## CO-W300-30W

4,800LM±5%  
1.5kg±5%  
280x134x112mm

## CO-W300-50W

8,000LM±5%  
1.5kg±5%  
280x134x112mm

## CO-W300-80W

12,800LM±5%  
1.7kg±5%  
280x134x112mm

## CO-W300-100W

16,000LM±5%  
1.7kg±5%  
280x134x112mm

## CO-W300-150W

24,000LM±5%  
2.8kg±5%  
345x172x163mm

## CO-W300-200W

32,000LM±5%  
2,85kg±5%  
345x172x163mm

## Specifications

WATTAGE	30/50/80/100/150/200W
LAMP EFFICIENCY	160LM/W±5%
CRI	Ra>70/80
CCT	2700-6500K
RATED VOLTAGE	AC 100-240V 277V~, 50/60Hz
POWER FACTOR	>0.95
IP GRADE	IP66
IK GRADE	IK10
BEAM ANGLE	Asymmetric G6
OPERATING TEMP	-40°C~60°C

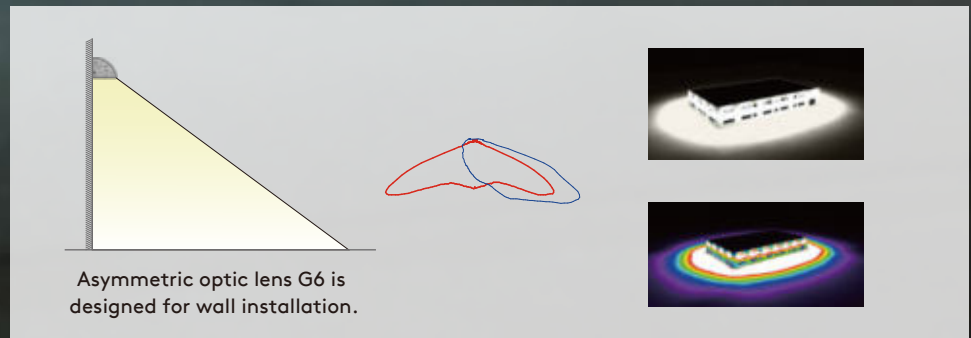
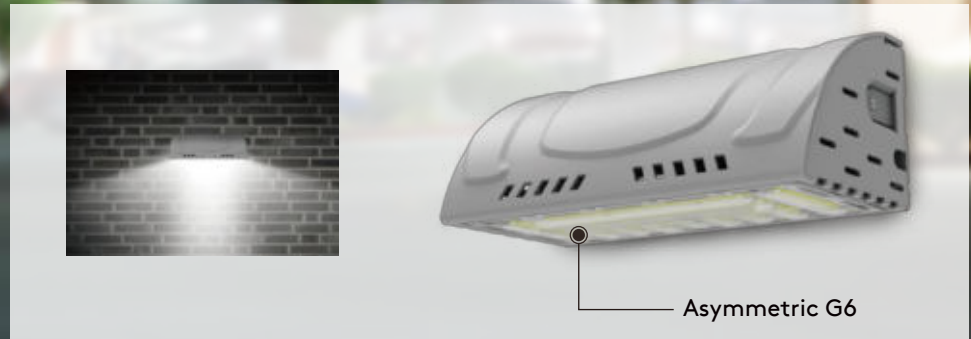

# LED Linear Light X300



CO-X300-20W-600      CO-X300-30W-600

3,000LM±5%	4,500LM±5%
0.7kg±5%	0.8kg±5%
42PCS LED	60PCS LED
605x56.1x54.3mm	605x56.1x54.3mm

CO-X300-40W-600      CO-X300-60W-600

6,000LM±5%	9,000LM±5%
0.8kg±5%	0.8kg±5%
84PCS LED	126PCS LED
605x56.1x54.3mm	605x56.1x54.3mm



CO-X300-20W-600\*2      CO-X300-30W-600\*2

6,000LM±5%	9,000LM±5%
1.5kg±5%	1.5kg±5%
84PCS LED	120PCS LED
605x111.2x50.2mm	605x111.2x50.2mm

CO-X300-40W-600\*2      CO-X300-60W-600\*2

12,000LM±5%	18,000LM±5%
1.6kg±5%	1.6kg±5%
168PCS LED	252PCS LED
605x111.2x50.2mm	605x111.2x50.2mm



CO-X300-60W-1200      CO-X300-80W-1200

9,000LM±5%	12,000LM±5%
1.4kg±5%	1.4kg±5%
120PCS LED	168PCS LED
1205x56.1x54.3mm	1205x56.1x54.3mm



CO-X300-60W-1200\*2      CO-X300-80W-1200\*2

18,000LM±5%	24,000LM±5%
2.8kg±5%	2.9kg±5%
240PCS LED	336PCS LED
1205x111.2x50.2mm	1205x111.2x50.2mm

## Specifications

LAMP EFFICIENCY	150LM/W±5%
BEAM ANGLE	A4
CRI	Ra>70
CCT	2700-6500K
RATED VOLTAGE	AC 100-240V 277V~, 50/60Hz
POWER FACTOR	>0.95
OPERATING TEMP	-30°C~50°C

## Feature

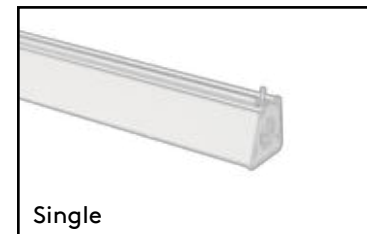

## Installation



## Combination Function

A. Ceiling Installation

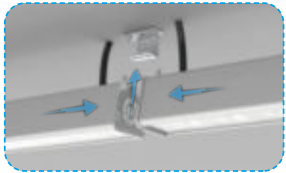
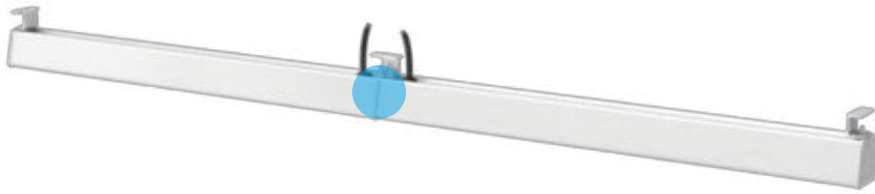

B. Suspended Installation

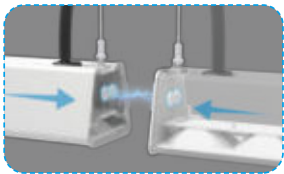
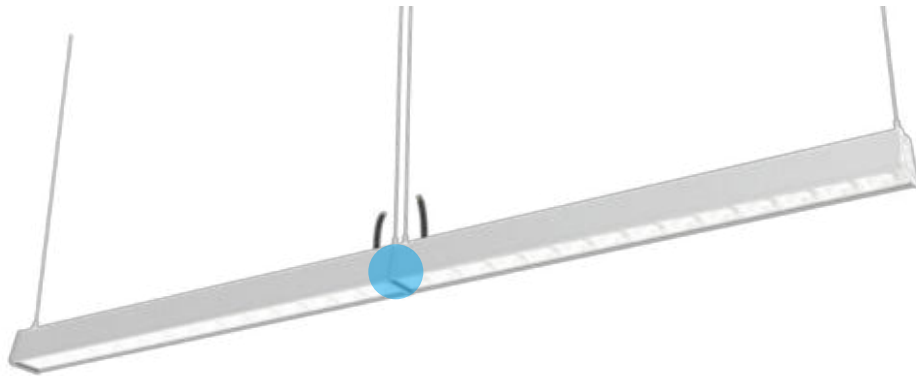

**150LM/W**  
Integrated and high CRI design, easy installation and unique anti-glare design, and the light emitted is very soft.



# Display Linear Light X300Z



CO-X300Z-20W-600  
3,000LM±5%  
0.7kg±5%  
605x65.7x65.7mm

CO-X300Z-40W-600  
6,000LM±5%  
0.8kg±5%  
605x65.7x65.7mm

CO-X300Z-30W-600  
4,500LM±5%  
0.8kg±5%  
605x65.7x65.7mm

CO-X300Z-60W-600  
9,000LM±5%  
0.8kg±5%  
605x65.7x65.7mm



CO-X300Z-60W-1200  
9,000LM±5%  
1.4kg±5%  
1205x65.7x65.7mm

CO-X300Z-80W-1200  
12,000LM±5%  
1.5kg±5%  
1205x65.7x65.7mm

## Specifications

WATTAGE	20/30/40/60/80W
LAMP LUMINOUS FLUX	150LM/W±5%
CRI	Ra>70(80/90)
CCT	2700-6500K
RATED VOLTAGE	AC 100-240V 277V~, 50/60Hz AC 200-240V 277V~, 50/60Hz
POWER FACTOR	>0.95
BEAM ANGLE	A4
OPERATING TEMP	-30°C~50°C

## Feature

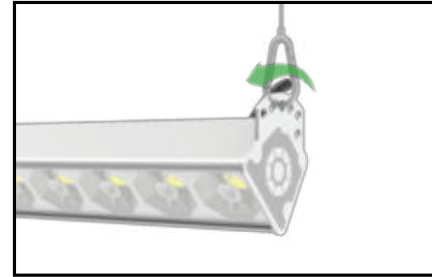

- Wide Irradiate Range
- Comfortable Lighting
- Simple Operation
- Adjustable Irradiation Direction

Optional magnetic end,  
make this more than simple.

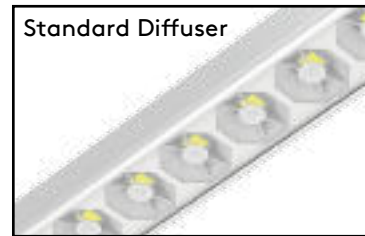
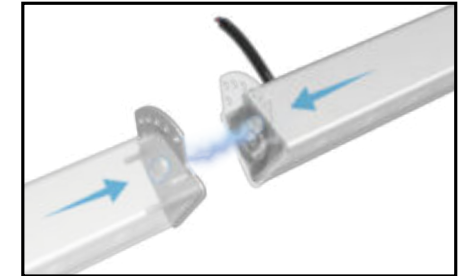

## Installation



# Tower Light TL-300

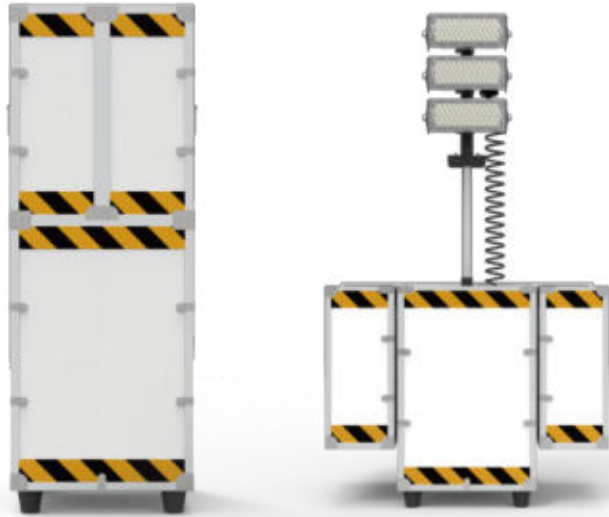

## Specifications

BRIGHTNESS	100%	50%	20%
LUMINOUS FLUX	25,000LM	13,500LM	7,000LM
BATTERY LIFE	120min	270min	720min
CCT	5000K (2700-6500K Optional)		
RATED VOLTAGE	100-240V, 277V~		
OPERATING TEMP	-30 C~50 C		
CHARGING TIME	120min		
STORAGE HEIGHT	1.18m		
MAXIMUM HEIGHT	2.4m		
SIZE	440x404x1150mm		
WEIGHT	32.0kg		

## Features

### Portable

Compared with traditional mobile light towers, TL-300 is equipped with wheels for easy movement.

### Bright, High Luminous Flux

The luminous flux of up to 25000 LM is unmatched by other mobile light towers on the market.

### More Than 12 Hours Of Battery Life

The lighthouse provides two modes of use. When it is fully charged, it can be used independently for more than 12 hours, or it can be used while charging, so you can't worry about battery life.

### Convenient Operation

You can complete the entire operation of starting the tower light in one minute, which is efficient and fast.



# Solar Light S300



CO-S300-30W

3,052LM(MAX)  
8.0kg±5%  
212x102x805mm

CO-S300-50W

6,046LM(MAX)  
10.5kg±5%  
212x102x1105mm

## Specifications

	30W	50W
SOLAR PANEL	30W	50W
BATTERY CAPACITY	160WH	260WH
BATTERY SERVICE LIFE	7 years at 70% DoD	
SOLAR PANEL SERVICE LIFE	20 years	
LED LIFETIME	153,135hrs/L70	
IP GRADE	IP66	
CCT	2700-6500K	
CRI	Ra>70	
OPERATING TEMPERATURE	-20 C~60 C	
WORKING TIME	3~5days	
SPIGOT DIAMETER	60/80mm	
TYPICAL INSTALLATION HEIGHT	3-8m	

## Feature



- PIR Sensor
- Timing Adjustment
- Programmable Working Mode
- Monocrystalline Solar Panel
- New Generation Of MPPT Controller
- LiFePO4 Batter

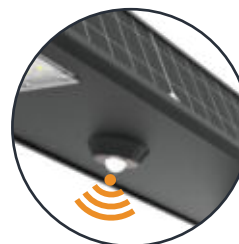

PIR sensor option



Arc bracket rotatable ±90°

## Installation



Spigot: 60mm



Spigot: 80mm





## About Company

Since 2011 Shenzhen Coming Technology Co., Ltd has specialised in the design and manufacture of innovative LED lighting products and associated services. In addition to unique and high quality products we also provide professional support for all our products to ensure our customers make the most of our capabilities, including:

High bay light | Flood light | Street light | Down light | Track light | Bulkhead light | Post top light | Wall light  
OEM/ODM service | Project solutions | Dialux simulation

We always value comments from our customers. For further information please contact us on [info@co-ming.com](mailto:info@co-ming.com).



## PROJECT GALLERY

### Commercial Lighting



### Architectural Lighting





Outdoor Lighting

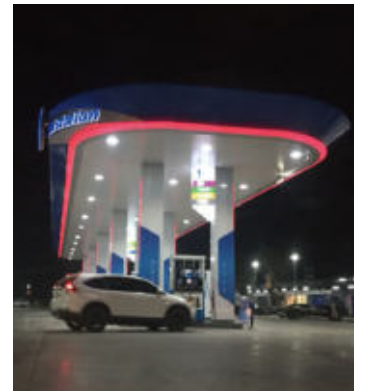
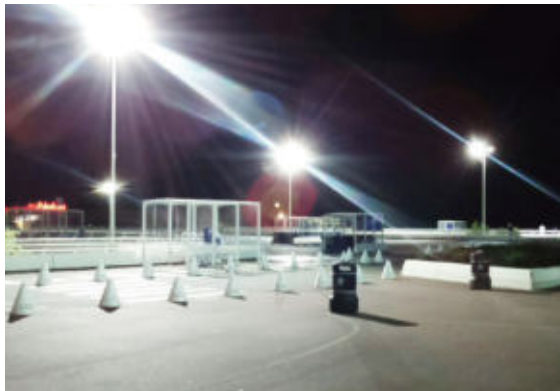
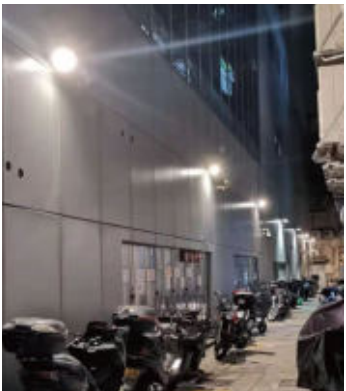
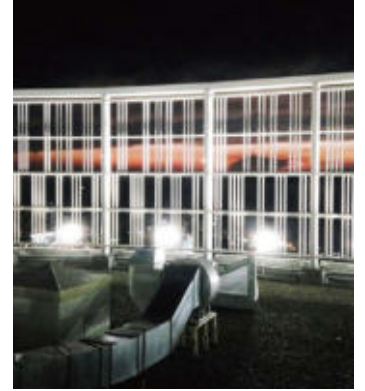
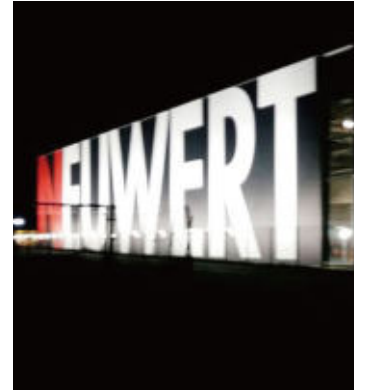

Industrial Lighting





## Sports Field Lighting

