



- PLATINUM multi-core LED technology
- Up to 4,400 delivered lumens
- Excellent efficacy > 110lm/w
- 20W, 30W and 40W variants
- 5 year warranty
- X-treme durability and toughness
- Lightweight design
- UK designed and manufactured
- Intelligent driver programme options
- Optional photocell

The Urban-X Mini is a powerful, lightweight luminaire designed for a range of perimeter, fence line, street, pathway and industrial lighting applications and is designed and manufactured in the UK.

The Urban-X Mini utilises the latest high power PLATINUM multi-core LEDs to deliver a high lumen output of up to 4,400 delivered lumens on scene. It produces a highly even light distribution with excellent colour rendition. With a low power consumption and high efficacy, the URBAN-X Mini delivers class leading performance.

The luminaire offers X-treme levels of durability and toughness. Every unit is produced from LM6 marine grade cast Aluminium and is supported by a 5 year warranty. All Urban-X Mini luminaires are environmentally protected (IP66) with a wide temperature range (-30°C to +60°C (-22°F to 140°F)). They also have in-built protection from electrical surges (2kV with photocell, 8kV without photocell) and are impact resistant (IK08).

Urban-X Mini is available with an optional photocell and, thanks to its intelligent driver, customers can also choose from several pre-installed driver programs. Raytec can also develop bespoke programs tailored to a customer's exact requirements. Meanwhile, DALI compatibility gives users greater levels of control and functionality.

Product Dimensions

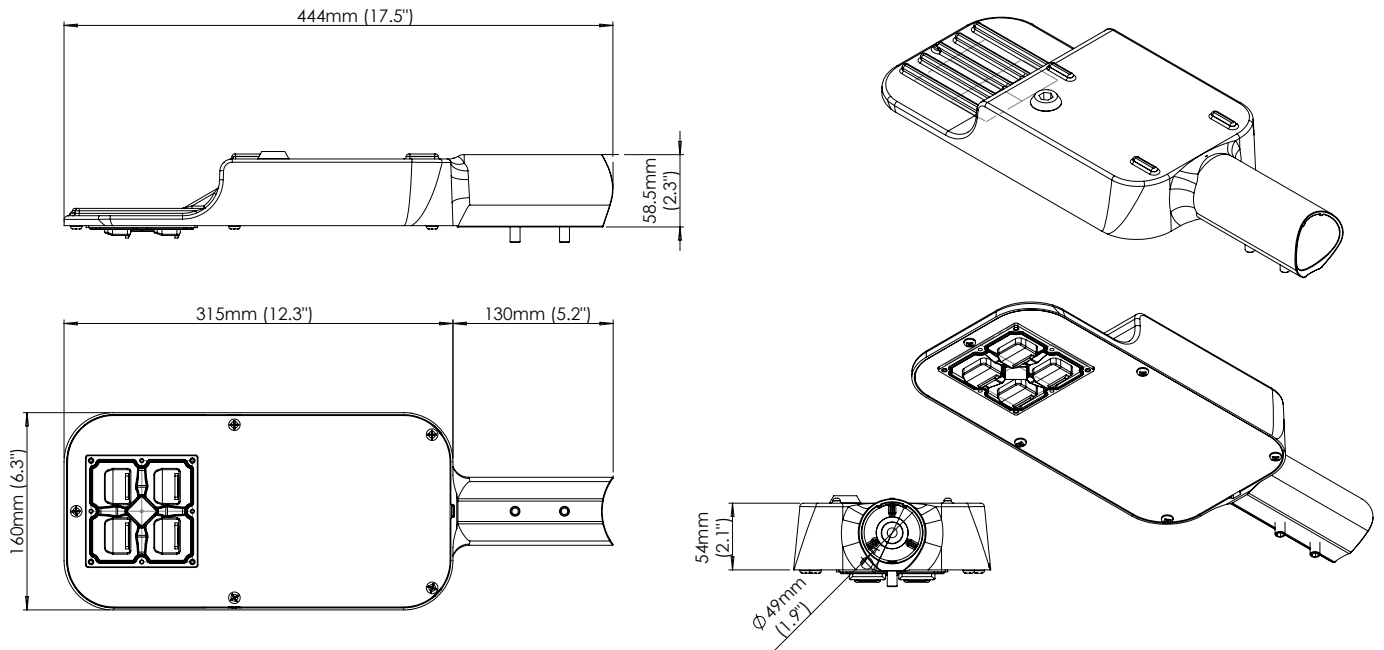

Features	Benefits
PLATINUM Multi-Core LED Technology	The Urban-X Mini utilises the latest PLATINUM Multi-Core LED technology together with an enhanced Cool Running™ thermal management system to deliver excellent performance and a light output of up to 4,400 lumens
Energy Saving	With a low power consumption of up to 40W and a high efficacy of 110lm/w, the luminaire delivers significant energy savings and outstanding optical performance
X-Treme Durability and Toughness	The Urban-X mini is manufactured from LM6 marine grade cast aluminum to give environmental protection (IP66) and safeguard against high salinity, while also being impact resistant (IK08). An inbuilt automatic thermal control (ATC) makes the luminaire suitable for high temperature installations and every unit features surge protection (2kV with photocell, 8kV without photocell)
Optics for Any Application	A wide choice of beam patterns tailored to achieve the best results for specific applications such as pathway, perimeter and area lighting
Lightweight	Every Urban-X Mini is a 1 piece, lightweight design (2kg (4.4lbs)) which means the luminaire can be safely and easily installed
Intelligent and Controllable	Urban-X Mini is available with a variety of options including a fully programmable driver and/or an optional photocell for full intelligent lighting installations. Intelligent features include DALI compatibility, part night dimming, time & scheduling commands
Integrated Horizontal Spigot Mount	With a convenient integrated spigot mount, the luminaire can be fixed to any horizontal pole arrangement with a diameter of up to 42mm (1.65"). Other bracket options available

5 YEAR WARRANTY

All Raytec luminaires are provided with an industry leading 5 year warranty and have an expected useful life in excess of 10 years



Technical Specifications

Electrical

Input:	220-240V AC
Frequency:	50 - 60Hz
Power Factor:	>0.95 VAC at 230V 50Hz
Efficiency:	>80% 230VAC, Full load
Surge Protection:	Without photocell: 8kV With photocell: 2kV
Consumption:	20, 30 and 40W versions (model dependent)

Mechanical and Control

Spigot (pole) Diameter:	Compatible with up to 42mm (1.65")
Bracketry:	Supplied with Integrated Horizontal Spigot Mount (vertical entry bracket available on request)
Finish:	Silver (RAL 9006) polyester powder coating
Cable Length:	No cable as standard 8m and 12m options available 3 core or 5 core (DALI) options available.
Dimensions:	160 x 444 x 58.5mm (6.3 x 17.48 x 2.3")
Weight:	2kg (4.4lbs)
Photocell:	Optional mini photocell Other photocell options available

Optical

Total Lumens:	20W - 2,200lm 30W - 3,300lm 40W - 4,400lm
Angle:	See beam angle options below
LED Type:	PLATINUM Multi-Core LED
Number of LEDs:	4
Wavelength:	White-Light
Colour Temperature:	4000K (other options available)
Colour Reproduction Index (CRI):	≥70

Environmental and Safety

Temp Range:	-30° to +60°C (-22 to 140°F) with automatic thermal control
IP Rating:	IP66
Safety:	EN60598 Approved
Warranty:	5 Years
Country of Manufacture:	United Kingdom
Impact Resistance:	IK08
Salinity:	LM6 marine grade cast aluminium

Light Distribution

Urban-X is available with a choice of three standard beam angles to suit a wide range of applications (other options available).

Perimeter/Pathway - PP1

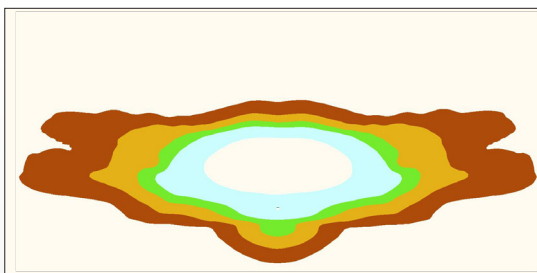

Perimeter/Pathway - PP2

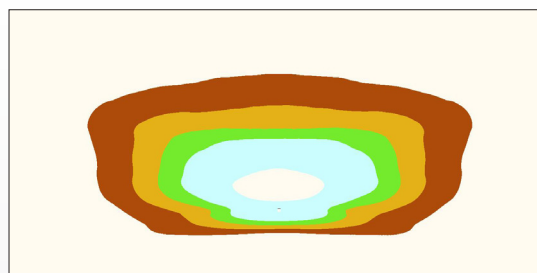

Area - AR1

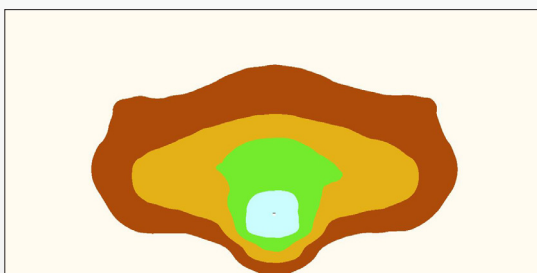

Beam angles and lux levels are based on a typical installation with a 4m (13ft) mounting height over a 10x20m (33x66ft) area.

Intelligent Driver Program Options

The intelligent driver option in Urban-X allow the illuminator to be pre-programmed during manufacture to give the best performance for any application. Raytec offer 5 standard programming options:

ID1 - Soft Start

The luminaire operates at 100% output with a 5 second soft start from power being applied to the unit or from the photocell activation (when fitted).

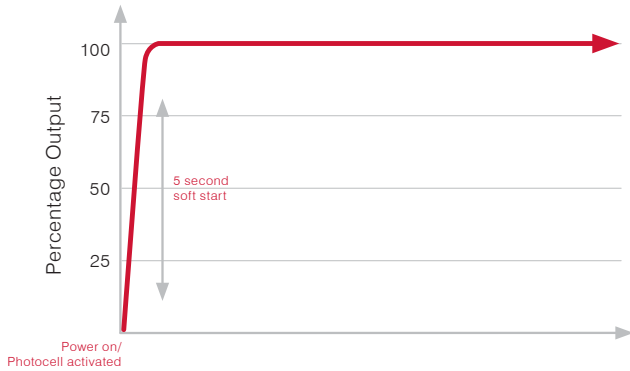

ID2 - Timer Dimming

The luminaire operates at 100% power for 5 hours from power being applied or from photocell activation (when fitted) and then switches to 50% power until the next cycle.

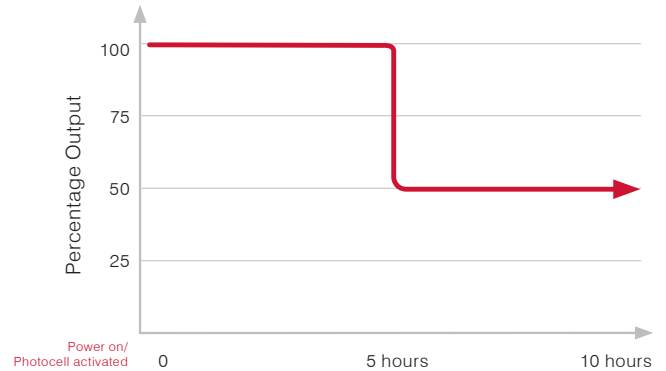

ID3 - Active Dimming 50%, ID4 - Active Dimming 25%

The luminaire's driver records the length of consecutive nights and dims to either 50% (ID3) or 25% (ID4) power, 1 hour before the midpoint of the night and up to 6 hours after, to deliver significant energy savings.

This program would typically require the use an inbuilt or remote photocell to monitor the hours of darkness.

Longer night (typical example) ■ ID3 ■ ID4

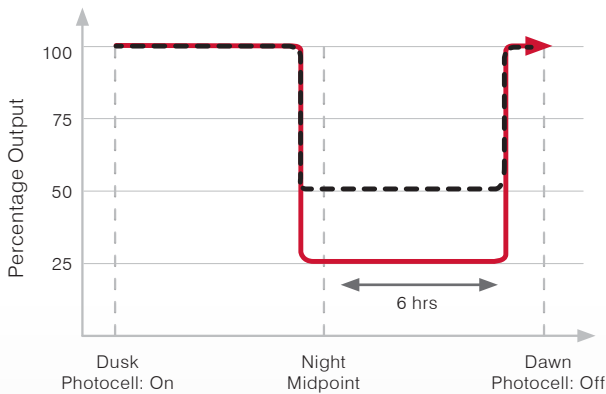

Shorter night (typical example) ■ ID3 ■ ID4

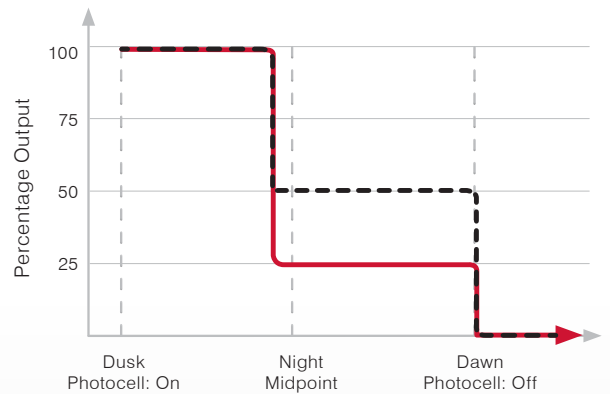

ID5 - Event Trigger

Designed to be used in conjunction with other control equipment, once power is applied, or triggered, the luminaire will operate at 100% for 30 minutes and then switch off until re-activated.

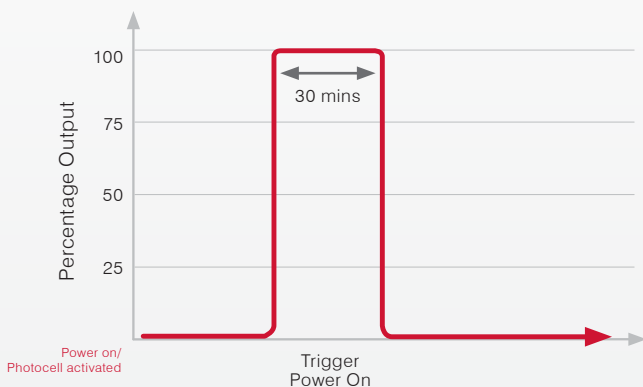

IDx - Custom

A customer specified intelligent driver program that Raytec will develop and pre-install (contact Raytec for more information).

*Programmes (ID2-ID5) also feature a 5 second soft start as shown in ID1

Product Code Builder

Example Order Reference: **UBXMIN40-4KPP2-ID1NP-2**

Core Product			Optics		Control		Input	Optional Extras
Product Family	Model Size	Wattage	Colour Temp*	Optics	Driver	Photocell	Input	Cable*
UBX (Urban X)	MIN (Mini)	20 (20W)	4K (4,000K)	PP1 (Path/permiter 1)	ID1 (Soft Start)	PC (With photocell)	2 (220-240V)	8M (3 core cable, 8m)
		30 (30W)		PP2 (Path/permiter 2)	ID2 (Timer Dimming)	NP (Without photocell)		12M (3 core cable, 12m)
		40 (40W)		AR1 (Area 1)	ID3 (Active Dimming 50%)			8MD (DALI cable, 8m)
					ID4 (Active Dimming 25%)			12MD (DALI cable, 12m)
					ID5 (Event Trigger)			
					IDx (Bespoke options available. Contact Raytec for information)			

*Other options available

*Not supplied as standard