

I71

5MP with D/N, Advanced WDR, SLLS,



- 5 Megapixel
- Day & Night with Superior Low Light Sensitivity
- Fisheye Lens with f1.05mm/F2.8
- Advanced WDR
- 360°/180° Panorama View with Dewarped Streaming
- Event trigger, response and notification

► Specifications

Device

Product Type	Hemispheric Dome
Maximum Resolution	5MP
Application Environment	Outdoor
Image Sensor	Progressive Scan CMOS
Sensor Size	1/2.5 "
Effective Pixels	2592(H) X 1944(V) (5.04 MP)
Day / Night	Yes
Low Light Sensitivity	Superior
Minimum Illumination	Color: 0.1 lux at F2.8 (30 IRE , 2400 K); B/W: 0.05 lux at F2.8 (30 IRE, 2400 K)
Color to B/W Switch	ISP based switch, configurable
Mechanical IR Cut Filter	Yes
IR Sensitivity Range	700-1100nm
IR LED	No
Electronic Shutter	1/5-1/2000 second (manual mode); 1/5-1/10000 second (auto mode)
Horizontal Resolution (TV Lines)	1850 TVL

S/N Ratio	56 dB
-----------	-------

Lens

Focal Length	Fixed focal, f1.05mm
Aperture	F2.8
Iris	Fixed iris
Focus	Fixed focus
Lens Mount	Board mount
Horizontal Viewing Angle	189.7° (overview area) 115.7° (high detail area)
Vertical Viewing Angle	190° (Fisheye View)
Viewing Angle Adjustment	Rotation: -175°-175°

Video

Compression	H.264 (Baseline/ Main/ High profile), MJPEG
Maximum Frame Rate vs. Resolution	(Fisheye View) 15 fps at 2592 x 1944 15 fps at 2048 x 1536 30 fps at 1440 x 1080 30 fps at 1280 x 960 30 fps at 800 x 600 30 fps at 640 x 480 15 fps at 320 x 240 (Dewarped View) 12 fps at 2592 x 1944 12 fps at 2048 x 1536 12 fps at 1920 x 1080 12 fps at 1280 x 720 12 fps at 640 x 480 12 fps at 320 x 240 (ePTZ View) 12 fps at 1920 x 1080 12 fps at 1280 x 720 12 fps at 640 x 480 12 fps at 320 x 240
View Mode	Fisheye View Dewarped View ePTZ View
Multi-Streaming	Simultaneous dual streams based on two configurations
Bit Rate	28Kbps - 6Mbps (per stream)
Bit Rate Mode	Constant, Variable
Wide Dynamic Range	Advanced WDR (80 dB)
Image Enhancement	White Balance, Brightness, Contrast, Sharpness, Automatic gain control, Flickerless, Defogging
Digital Noise Reduction	2D + 3D DNR
Privacy Mask	4 configurable regions
Text Overlay	Yes
On-Screen Graphics	Yes
Server-based Analytics	Object Line Counting, People Counting, Face Detection, Object Based Motion Detection, Tamper, Object Line Crossing Detection, Object Enter Area Detection, Missing Object Detection, Unattended Object Detection, Smoke Detection, Heat Map, Dwell Time, Direction Detection, Automatic License Plate Recognition, People Queue Detection, (Require PC-based or standalone IVS or ALPR Server. Contact ACTi support for recommendations on how to maximize analytical accuracy)
Image Orientation	Flip, Mirror, Rotation (Corridor mode)

Audio

Audio Type	2-way, Line-in, Line-out
Audio Compression	8 kHz, 16 bit encoding, Mono, PCM, G.711

Network

Network Protocol & Service	IPv4/v6, TCP, UDP, DHCP, PPPoE, HTTP, HTTPS, DNS, DDNS, NTP, RTP, RTSP, RTCP, SMTP, FTP, IGMP, ICMP, ARP, Bonjour, UPnP, QoS, SNMP, IEEE 802.1X
----------------------------	---

Ethernet Port	1 x RJ-45 connector
Security	IP address filtering, HTTPS encryption, Password protected user level, Anonymous login, IEEE 802.1X network access control

Event

Event Trigger	Video motion detection (3 regions), External device through digital input, Sound detection,
Event Response	Notify control center, Go to ePTZ preset point or preset tour, Change camera settings, Command other devices, E-mail notification with snapshots, Play the audio file, Push notification to mobile device, Save video to local storage, Upload video or snapshot to FTP server, Upload video to NVR server, Activate external device through digital output

Integration

Unified Solution	Fully compatible with ACTi software
Software Development Kit	Yes
GPS Position	Manual setting
ONVIF Compliant	Yes, Profile S, Profile G, Profile T, Profile Q
GB28181 Compliant	Yes
Web Browser	IE 11
Auto Firmware Upgrade	Yes

Interface

Audio Interface	Terminal block
Local Storage	MicroSDHC, MicroSDXC Memory Card Slot (card not included, up to 256GB)
Digital Input/Output	2/2

General

Power Source	DC 12V, PoE Class 3 (IEEE802.3af)
Power Consumption	7.06 W (PoE)
Weight	909g (2lb)
Dimensions	(Ø x H): 152mm x 66mm (6" x 2.6")
Environmental Casing	Weatherproof (IP68), Vandal proof (IK10)
Mount Type	Surface, Rough Surface, Gang Box, Pendant, Tilted Mount, Wall Mount, Pole Mount, Corner Mount
Starting Temperature	-40°C ~ 50°C (-40°F ~ 122°F)
Operating Temperature	-40°C ~ 50°C (-40°F ~ 122°F)
Operating Humidity	10% - 85% RH
Approvals	CE Class B, FCC Class B, EAC, IP68, IK10, NEMA 4X, ETL Listed
Real-time Clock (RTC)	Yes
Warranty	3 Year(s). For extended warranty offering, see http://www.acti.com/support/warranty

► Photo Indication



- 1 Reset Button
- 2 Audio Input / Output
- 3 Ethernet Port
- 4 DC 12V Power Input
- 5 Memory Card Slot
- 6 Digital Input/Output



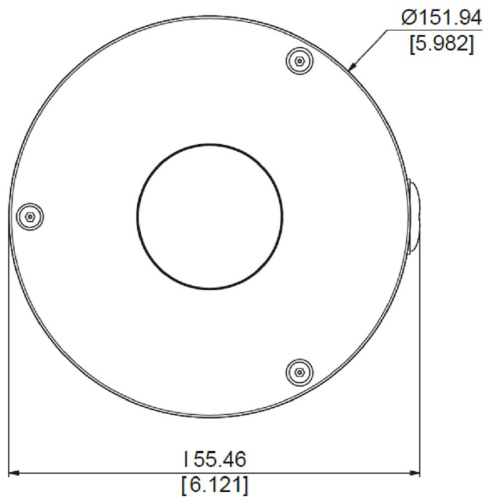
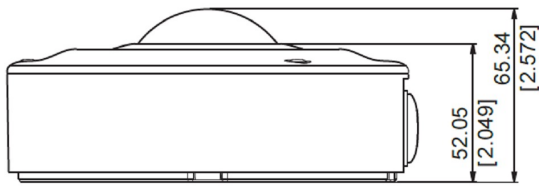











► Dimension Diagram



Unit: mm [inch]

► Related Products

Mounting Accessories - Camera Mount

PMAX-0101		Mount Kit for all Dome Cameras (except Mini Domes)
PMAX-0102		Straight Tube
PMAX-0103		Straight Tube with Bracket
PMAX-0104		Extension Tube
PMAX-0310		Tilted Wall Mount for Indoor Hemispheric/Fisheye Cameras
PMAX-0314		Heavy Duty Wall Mount for Outdoor Domes (for B8x, B9x, D7x, D8x, E7x [except E78], E8x, I7x)
PMAX-0330		10-Degree Tilted Wall Mount for Outdoor Hemispheric Cameras
PMAX-0338		35-Degree Tilted Wall Mount for Fisheye and Hemispheric Cameras
PMAX-0402		Corner Mount
PMAX-0503		Pole Mount (for PMA-0102, PMA-0312, PMA-0313, PMA-0314, PMA-0702, PMA-1106, PMA-1107), supports 5.25" to 8.5" Poles
PMAX-0504		Pole Mount (for B4x, B41x, E44, E45, E46, E48, E44A, E45A, E46A, E41x, I4x, PMA-0330), supports 3.25" to 7.0" Poles
PMAX-0505		Pole Mount (for B4x, B41x, E44, E45, E46, E48, E44A, E45A, E46A, E41x, I4x, PMA-0312, PMA-0313, PMA-0314, PMA-0330), supports 2" to 3" Poles
PMAX-0702		Junction Box for PTZ and Dome Cameras
PMAX-0804		Gang Box Converter for Outdoor Domes, supports Two-Gang Boxes

Note: Some mounting accessories may need additional accessories for installation. Please check www.acti.com/mountingselector for more information.





Dome Covers - Smoked Dome Cover

PDCX-1110		Vandal Proof Smoked Dome Cover for B7x, I7x
-----------	---	---

Power Supply Accessories - Power Adapter

PPBX-0011		Power Adapter AC 100~240V, with universal connectors for all DC12V powered devices
-----------	---	--

Network & Storage Peripherals - Data Switch

PPSW-0100		PLANET FGSD-910HP 8-Port 802.3at PoE Switch (PoE Budget 120W)
PPSW-0102		PLANET FGSD-1011HP 8-Port 802.3at PoE Switch (PoE Budget 120W)
PPSW-1101		PLANET GS-4210-24PL4C 24-Port Gigabit 802.3at Managed PoE Switch (PoE Budget 440W)
PPSW-2101		4-Port 802.3at PoE Switch (PoE Budget 62W)
PPSW-3100		PLANET FGSW-1816HPS 16-Port 802.3at PoE Switch (PoE Budget 220W)

Extenders - PoE Extender

PPEX-0100		Veracity OUTREACH Max Power over Ethernet (PoE) Extender
-----------	---	--

Extenders - PoE over Coaxial Extender Kit

PPOC-0100		Planet LRP-101C-KIT Power over Coax Adapter Kit
-----------	---	---

Audio Devices - Microphone

PMIC-0100		Active Microphone Omnidirectional for all Cameras with Line-in Audio
-----------	--	--

Illuminators - IR LED Illuminator

PLED-0200		SPINLUX (SL-A2IRXX10-24CL) IR Illuminator 10° Angle with 120 m approx. range
PLED-0201		SPINLUX (SL-A2IRXX25-24CL) IR Illuminator 25° Angle with 50 m approx. range

Other Accessories - Accessory Part

R707-70001		Conduit Gland for Dome Cameras
------------	---	--------------------------------

Product Demo - Camera Demo Kit

PCDK-0001		Camera Demo Kit Rack Box (350 x 550 x 140 mm) for all cameras except Mini Domes
-----------	---	---

Installation Support - Camera Installation Kit

PMON-2000		Camera Installation Kit
-----------	---	-------------------------