







AMG110M-1X MINI INDUSTRIAL 1/2.5/5/10Gb 30/60/90/95W POE SURGE PROTECTORS



Industrial Ethernet Solutions

AMG's industrial Ethernet surge protectors provide robust protection for 1/2.5/5/10Gb Ethernet equipment with support for pass-through PoE up to 95W. These mini single channel models are designed to protect devices in space restricted installations.



 1/10 Gb x1	 Temp -40~+85°C	 Mounting DIN/Surface	 Protection IP40	 Surge Protection	 Mounting Magnetic	 NDAA/TAA Compliant
---	---	---	--	---	--	---

[AMG110M-1X-SP]

/ OVERVIEW

Designed in an ultra compact DIN rail or wall mount housing, the AMG110M series industrial Power over Ethernet (PoE) surge protectors are ideally suited for protecting network devices that may be susceptible to damage from surge or voltage transient events in space restricted installation environments.

Designed as a single channel surge protector supporting 1/2.5/5/10Gb Ethernet and transparent to all types of PoE including IEEE802.3at 30W or IEEE802.3bt 60/90W and non-standard PoE such as 95W.

Industry leading protection is provided to EN61000-4-5 and IEC/EN 61643-21 standards.

To ensure the correct protection the AMG110M must be correctly grounded to ensure any surge or transient voltage has an obstruction free path to ground which then protects the connected equipment from damage.

For installation examples refer to the product application diagrams and installation manual.

/ FEATURES

- Ultra compact size – ideal for confined spaces, including camera housings and roadside cabinets
- -40°C to +85°C temperature maintains performance in extreme conditions
- Plug & Play – no need for any user configuration
- DIN rail or wall mountable - quick to install and remove for maintenance (an optional magnetic mount is also available)
- RJ45 ports support 1/2.5/5/10Gb speeds
- Transparent to all Ethernet traffic including jumbo frames, multicast and VLAN's etc.
- Supports 15W, 30W, 60W, 90W and 95W PoE
- Integrated surge protection with up to 20kA discharge capability for maximum protection
- Designed in the USA & UK. Manufactured in the United Kingdom
- AMG Lifetime Support Warranty

Specifications.

Standards.

IEEE802.3i	10Base-T
IEEE802.3u	100Base-TX
IEEE802.3ab	1000Base-T
IEEE802.3bz	2.5/5GBase-T
IEEE802.3an	10GBase-T
IEEE802.3af	15W PoE
IEEE802.3at	30W PoE+
IEEE802.3bt	60 & 90W PoE

Jumbo Frames	Transparent to Jumbo Frames
VLAN Support	Transparent to VLAN traffic
Multicast Support	Transparent to Multicast traffic

Interface.

Ground Connection	1x M3 Earth Stud
RJ45 Ports	1x 100/1000/2.5G/5G/10G RJ45 In/Out Channel

Surge Protection*.

Technology	GDT
Surge Current Rating	20kA / Pair
Nominal Line Voltage	48-57V
Max DC Voltage	150V (@ 100V/s)
Max Impulse	
Spark-Over Voltage	500V (C3 Category 1KV/μs)
Nominal Current	1A (per pair)
Leakage Current	<1μA
DC Holdover	80V (<150ms)
Capacitance	<2pF
Impulse Current	2kA (D1 Category 10/350μs x 1)
Line/Line Nominal	
Discharge Current	2kA (C2 Category)
Line/Earth Nominal	
Discharge Current	10kA (C2 Category 8/20μs x 10)
Maximum Discharge	
Current	20kA (8/20μs x 1)
Response Time	<75ns
Protected Pairs	(1-2)(3-6)(4-5)(7-8)
Failsafe Mode	Short-Circuit / Cut-Off
Disconnect Indicator	Transmission Interrupt

*Earth must be connected for protection

Packaging.

Shipping Weight	0.24kg / 0.53lb
Dimensions	(W x D x H) 155 x 145 x 50 mm 6.10 x 5.71 x 1.97 in

Mechanical.

Housing	Anodised Aluminium
Dimensions:	(W x D x H) 31 x 57 x 57 mm 1.22 x 2.24 x 2.24 in
Excluding DIN & Wall Mounts	
IP Rating	IP40
Installation	Wall Mount or DIN-Rail Optional Magnetic Mounts
Weight	0.14kg / 0.31lb

Environmental.

Operating Temp.	-40 to +85°C / -40 to +185°F
Storage Temp.	-40 to +85°C / -40 to +185°F
Humidity	5% to 95% (non-condensing)
MTBF	>500,000 hours
MTBF Standard	Telcordia SR-332 GF 30°C
Cooling	Passive Cooling
Noise Level	0 dBA

Regulatory.

EMI	EN 55032 Class A CISPR 32 FCC Part 15B Class A
EMS	EN 55035 Class A
Surge	IEC/EN 61643-21 EN 61000-4-5 (Class 4)
Shock	IEC 60068-2-27
Free Fall	IEC 60068-2-32
Vibration	IEC 60068-2-6
Environmental	Reach RoHS WEEE
Supply Chain	NDA & TAA Compliant
Designed to meet	NEMA TS2 & UL497B

Application Diagram.

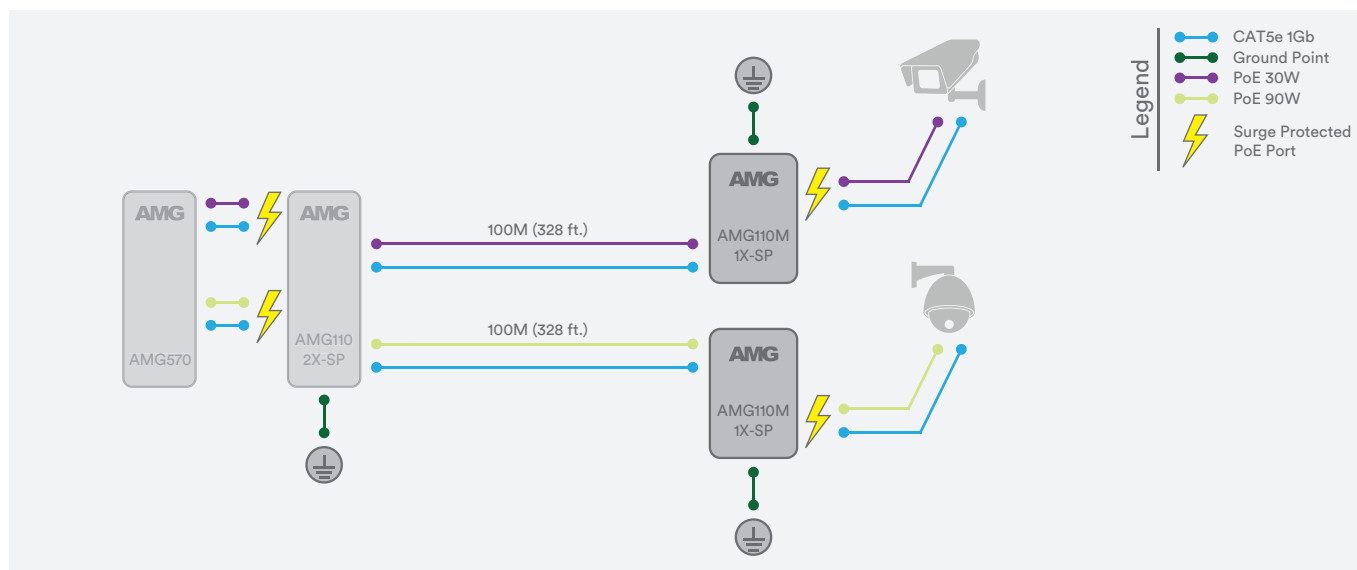

Part Numbers.

1/2.5/5/10Gb Industrial Mini PoE Surge Protectors

AMG110M-1X-SP

Industrial Mini Single Channel 30/60/90/95W PoE Surge Protector,
 1 × 10/100/1000/2.5G/5G/10GBase-T(x) RJ45 Port (Input),
 1 × 10/100/1000/2.5G/5G/10GBase-T(x) RJ45 Port (Output) With 20kA Surge Protection

Included Accessories.

DIN Rail Adapter
 Wall Mount Adapter
 Earth Cable

Rear/Side/Bottom Mounted Metal DIN Rail Clip & Screws For DIN Rail Mounting AMG110M Series Products
 Rear/Side/Bottom Mounted Wall Mounting Plate & Screws For Wall / Surface Mounting AMG110M Series Products
 385mm (15in) 14AWG Earth Cable With M3 & M5 Ring Terminals For Earth Connection To AMG110M Series Products

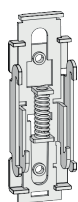

Optional Accessories.

AMG2035

Side Mounted Wall Bracket Adapter Kit For DIN Rail Mounting AMG110M Series Products In Depth Restricted Installations. Adapter Kit Can Be Extended Using The Included Extension Kit To Also Mount Additional Products.

AMGMNT-MAG-02

2x Rear/Side/Bottom Mounted Magnets & Screws Kit For AMG110M Series.

In a continuing effort to improve and advance technology, product specifications are subject to change without notice. Please visit www.amgsystems.com for the latest product specifications.

Proud to be a British
 Manufacturer 

AMG Systems Ltd. 4 Pioneer Way, Castleford, WF10 5QU, UK T: +44 (0) 1767 600 777 E: sales@amgsystems.com
 AMG Systems Inc. 62 Spring Hill Road, Trumbull, CT 06611, USA T: +1-855-AMGPOE1 (855-264-7631) E: usasales@amgsystems.com
 D35095-00 amgsystems.com

AMG